

TC-153SD

US Model
AEP Model
UK Model



PORTABLE STEREO CASSETTE-CORDER

SPECIFICATIONS

Power Requirements:	120 V AC, 60 Hz (USA) 220 V AC, 50/60 Hz (AEP) 240 V 50 Hz (UK) DC 6 V, four size "D" flashlight batteries or SONY rechargeable battery pack BP-8 or SONY car battery cord DCC-128	Inputs:	MICROPHONE (two) Impedance: for low impedance microphone Normal Level: -60 dB (0.77 mV) LINE IN (two) Impedance: 100 k Ω or more Normal Level: -10 dB (0.25 V) REC/PB Connector (AEP, UK) Impedance: less than 10 k Ω
Power Consumption:	12 W AC	Outputs:	LINE OUT (two) Impedance: 10 k Ω or more Normal Level: 0 dB (0.775 V) with 100 k Ω load HEADPHONE Impedance: 8 Ω REC/PB Connector (AEP, UK) Impedance: less than 10 k Ω
Track System:	Four-track two-channel stereo	Semiconductors:	44 transistors, 2 IC's and 35 diodes
Tape Speed:	4.8 cm/s (1 $\frac{7}{8}$ ips)	Motor:	D-009F
Frequency Response:	DOLBY NR OFF • With ferri-chrome cassette and chromium dioxide cassette: 30~15,000 Hz (NAB) 40~12,500 Hz (DIN) • With standard cassette 30~13,000 Hz (NAB) 40~11,000 Hz (DIN)	Speaker:	100 mm (4 inch) dia, 8 Ω
Signal-to-Noise Ratio:	DOLBY NR OFF • With ferri-chrome cassette and chromium dioxide cassette: 55 dB (at peak level, PB equalization 70 μ s) • With standard cassette: 53 dB (at peak level, PB equalization 120 μ s) DOLBY NR ON improved 5 dB at 1 kHz improved 10 dB at 5 kHz and above	Record/Playback Head:	PF145-3602A (F&F)
Wow and Flutter:	0.15 % WRMS (NAB) \pm 0.3 % (DIN)	Erase Head:	EF135-36
Record Bias Frequency:	Approximately 105 kHz	Dimensions:	378(w) x 108(h) x 238 (d) mm 14 $\frac{7}{8}$ (w) x 4 $\frac{1}{4}$ (h) x 9 $\frac{3}{8}$ (d) inches
Power Output: (at 10 % Distortion)	1.5 W (AC operation) 0.8 W (DC operation)	Weight:	5.4 kg, 11 lb 15 oz with batteries

* The word Dolby is the trademark of
Dolby Laboratories, Inc.

SONY
SERVICE MANUAL

SECTION 1
OUTLINE

1-1. BLOCK DIAGRAM

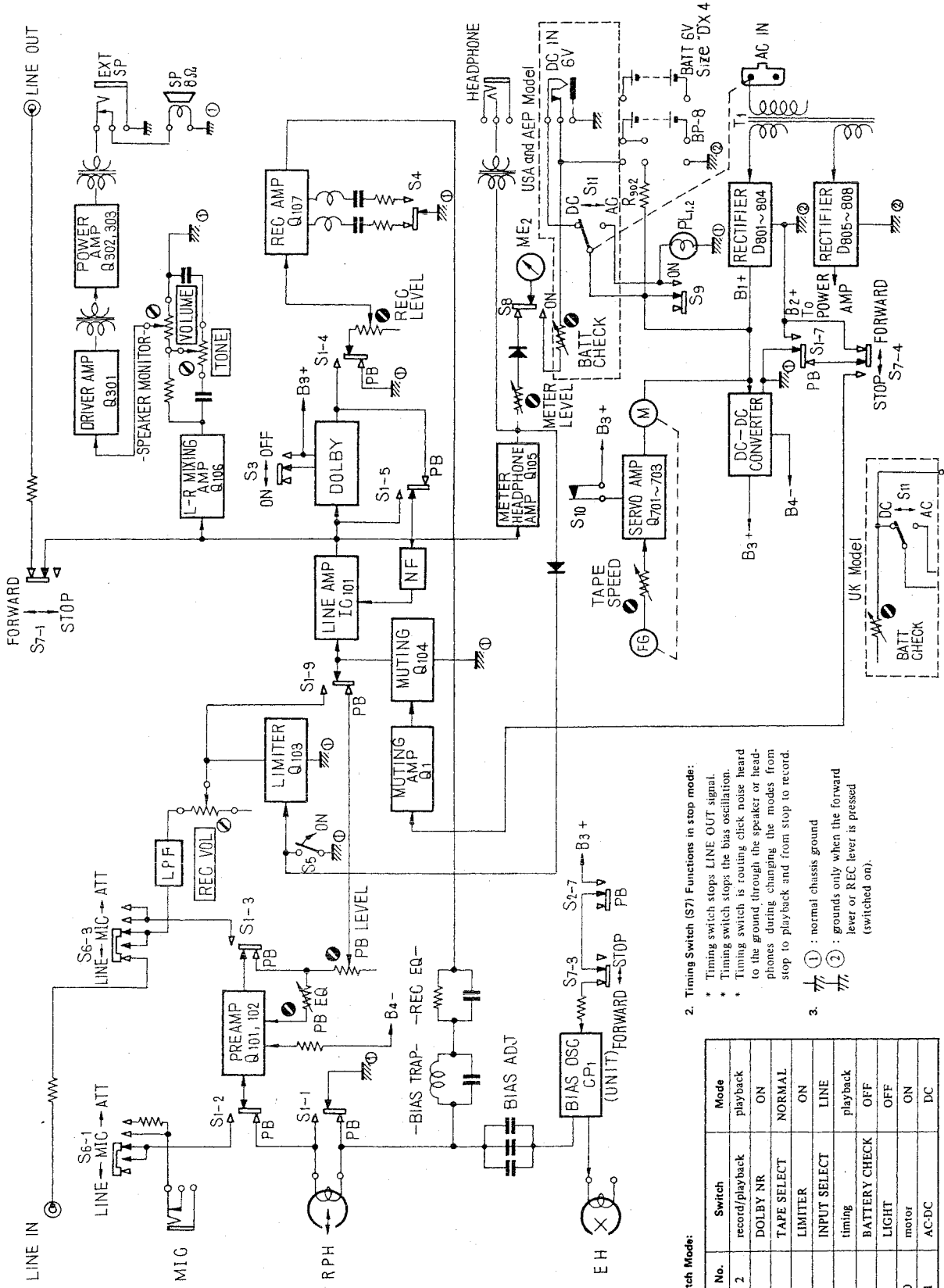

2. Timing Switch (S7) Functions in stop mode:
- * Timing switch stops LINE OUT signal.
 - * Timing switch is routing click noise heard to the ground, through the speaker or headphones during changing the modes from stop to playback and from stop to record.
3. Ⓛ : normal chassis ground
Ⓜ : grounds only when the forward lever or REC lever is pressed (switched on).

Note:

1. Switch Mode:

Ref. No.	Switch	Mode
S1, 2	record/playback	playback
S3	DOLBY NR	ON
S4	TAPE SELECT	NORMAL
S5	LIMITER	ON
S6	INPUT SELECT	LINE
S7	timing	playback
S8	BATTERY CHECK	OFF
S9	LIGHT	OFF
S10	motor	ON
S11	AC-DC	DC

1-2. EXTERNAL VIEWS

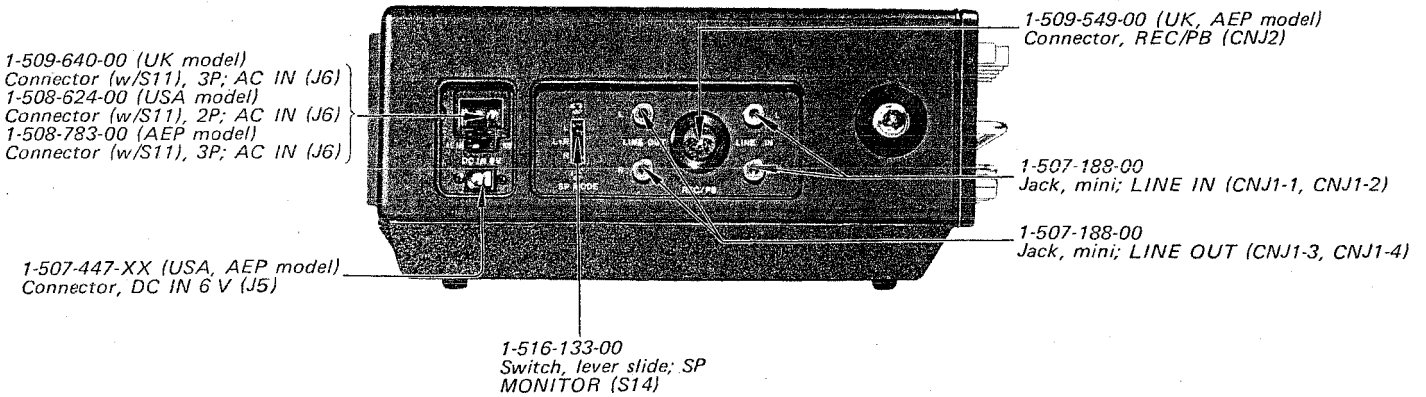
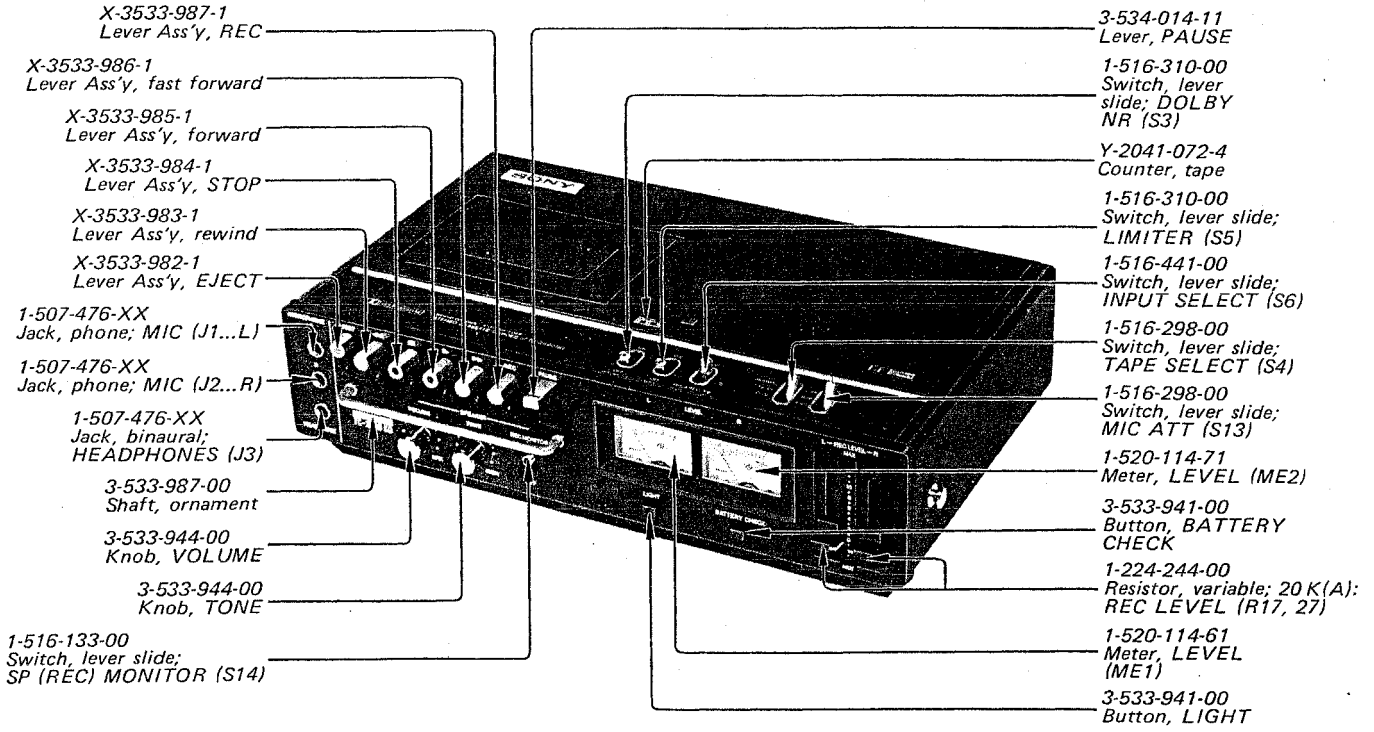

SECTION 3
ADJUSTMENTS

3-1. MECHANICAL ADJUSTMENTS

Head Height Adjustment

— playback mode —

Adjust by removing or adding the adjusting washer so that the tape is moved straightly without curl at positions shown by the arrows.

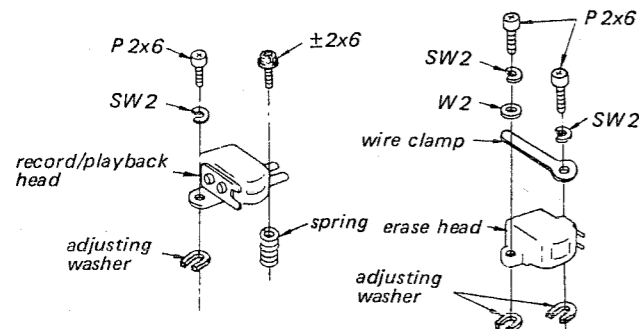
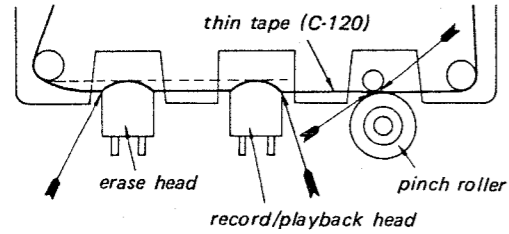

Part. No.	Description
3-513-237-01	adjusting washer (t=0.1)
3-513-237-11	adjusting washer (t=0.2)

Motor Current Measurements

With C-90 tape end, measure current as shown.

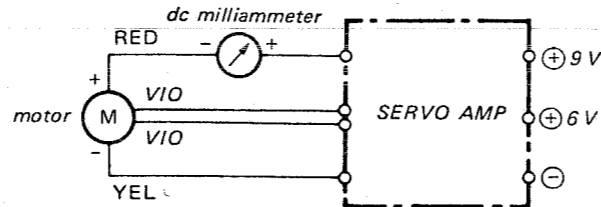

playback mode: 160 mA
fast forward mode } : 340 mA
rewind mode

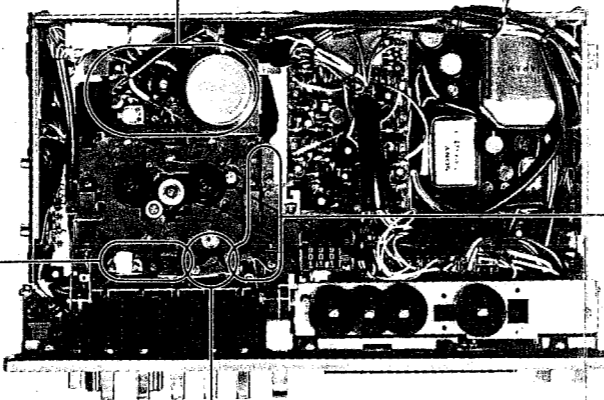

Pinch Roller Pressure Measurement

— playback mode —

With the unit in the playback mode, pull pinch roller away from the capstan using a spring scale, as shown in the figure. Return the pinch roller slowly. The pressure (spring scale tension) should be measured at the point where the pinch roller just contacts the capstan.

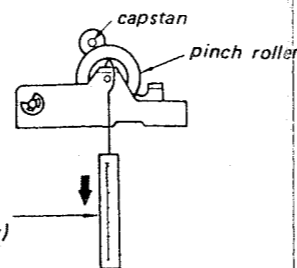

300 g to 350 g
(10.6 oz to 12.3 oz)

Automatic Shut-off Adjustment

In the playback or the record mode and with POWER switch OFF, turn the take-up reel spindle in the direction shown by the arrow

① until the joint rod moves to the full in the direction shown by the arrow ②. At this time, the cam gear and the capstan gear should completely mesh. If necessary, adjust the joint rod length by the adjustment screw.

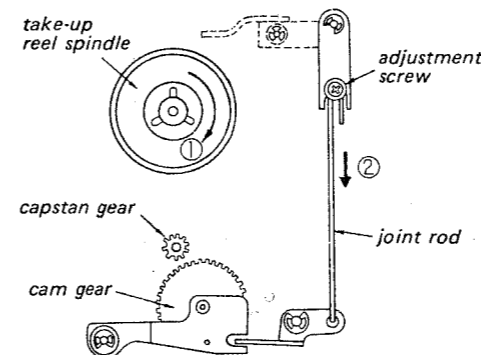

- Note:
1. Just when the unit is placed in the playback or the record mode, the clearance between the cam gear and the capstan gear should be more than 2 mm ($\frac{5}{64}$ inch).
 2. Automatic Shut-off Mechanism should operate within 5 sec. at the tape end.
 3. Automatic Shut-off Mechanism should not operate with mechanical shock during tape travel.
 4. As soon as a tape cassette with no tape remaining on the supply side is inserted, Automatic Shut-off Mechanism should operate.

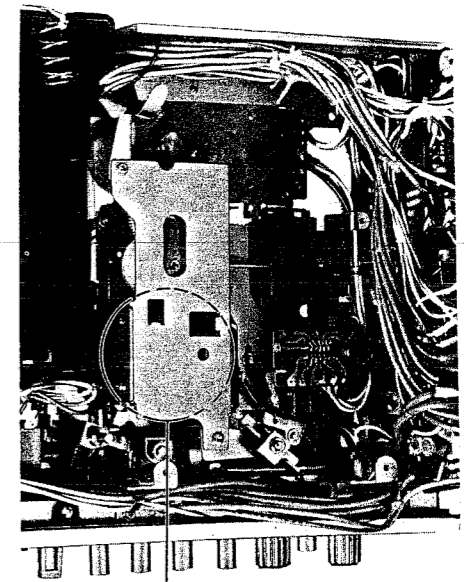

Flywheel Thrust Play Adjustment

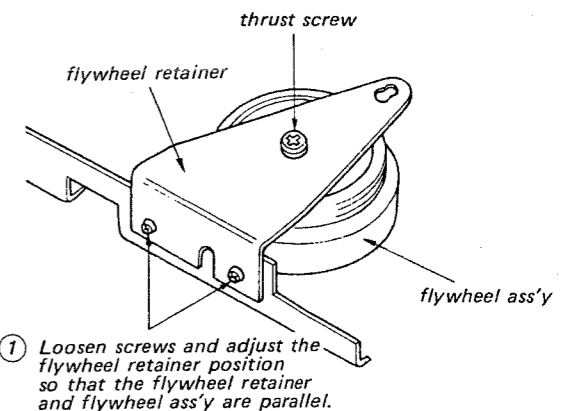

① Loosen screws and adjust the flywheel retainer position so that the flywheel retainer and flywheel ass'y are parallel.

② Adjust thrust screw so that the clearance between the thrust screw and the capstan is 0.2~0.4 mm ($\frac{1}{64}$ ")

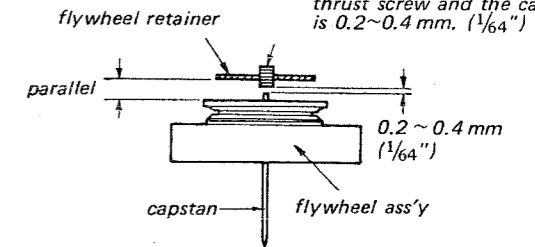

③ Make sure that the clearance between the capstan gear and the bearing is 1 mm ($\frac{3}{64}$ ")

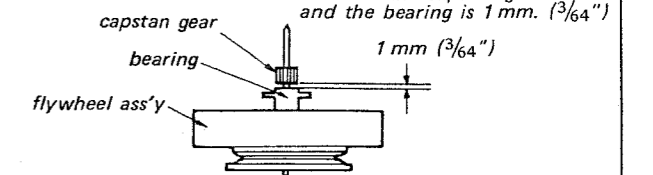

Note: When removing the capstan gear, do not use same one again. Use a new one. Part No. 3-519-034-00.

Motor Pulley Height Adjustment

— stop mode —

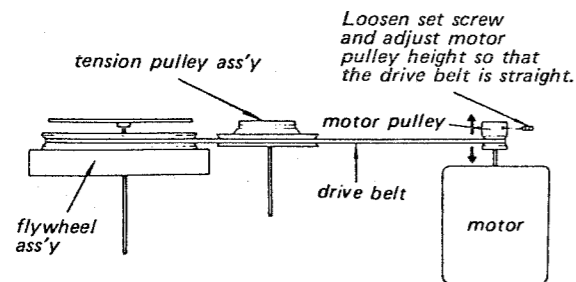

Forward Lever Timing Checks

Slowly depress the forward lever and make sure the following operations.

1. The brake separates from the both reel spindles.
2. The tension pulley contacts the take-up reel spindle.
3. The motor switch (S10) turns ON and the capstan starts to rotate.
4. The pinch roller contacts the capstan.

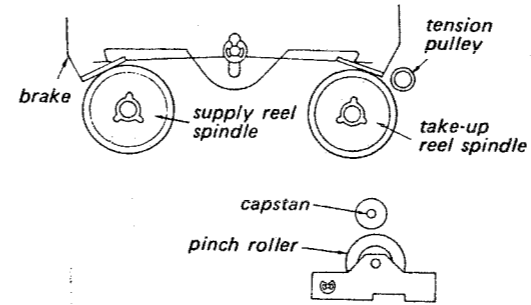

Motor Switch (S10) Adjustment

— stop mode —

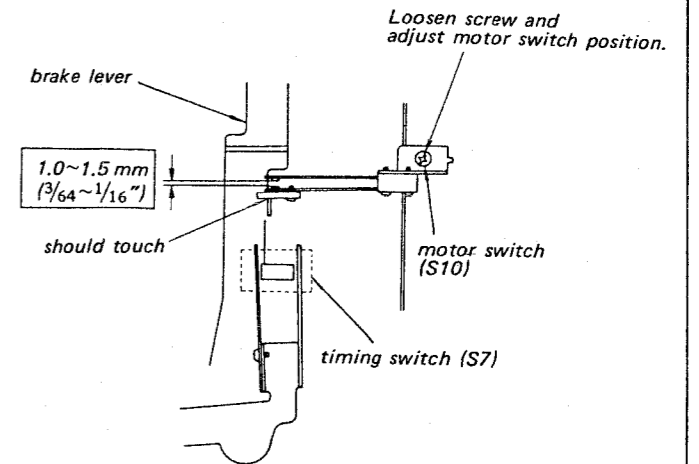

Slowly depress the forward lever and make sure that the timing switch (S7) turns ON after the motor switch (S10) turns ON (closes).

Fast Forward Spring Adjustment

— stop mode —

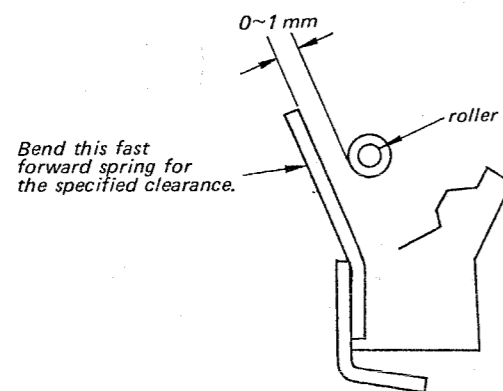

Af amp circuit board is lifted up.

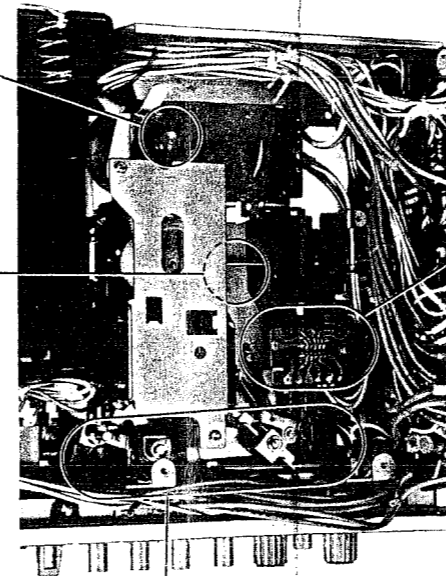

Record-playback Slide Position Adjustment

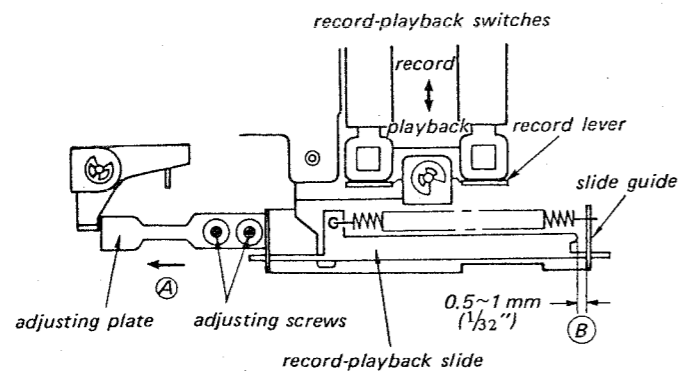

1. Loosen adjusting screws and move the adjusting plate to the full in the direction shown by the arrow (A) in the stop mode.
2. Tighten the adjusting screws.
3. When depressing record lever, make sure that
 - a) the clearance (B) between the record-playback slide and slide guide is 0.5~1 mm (1/32").
 - b) the record-playback switches are pushed by the record-lever and record-playback switches are completely changed over to the record mode position.
4. After above adjustments, make sure that the record-playback switches are not pushed by the record lever in the stop mode.

Torque Measurement

Mode	Torque
Playback	40 ~ 60 g · cm (0.56 ~ 0.83 oz · inch)
Fast forward Rewind	70 ~ 120 g · cm (0.99 ~ 1.65 oz · inch)

Checks After the Adjustments

- Forward, fast forward, rewind and REC levers can be locked. And the stop and EJECT levers cannot be locked.
- PAUSE lever can be locked by the first press and can be released by the second press.
- When depressing EJECT lever, cassette lid can be opened in forward mode.

Mode	Control Levers	Remarks
playback	fast forward rewind stop	possible to press
	REC	impossible to press
fast forward	forward rewind stop EJECT	possible to press
	REC	impossible to press
rewind	forward fast forward stop EJECT	possible to press
	REC	impossible to press
record	fast forward rewind stop	possible to press
	EJECT	impossible to press

3-2. ELECTRICAL ADJUSTMENTS AND MEASUREMENTS

Precaution:

1. Clean the following parts with an alcohol moistened swab:
 - * record/playback head
 - * pinch roller
 - * erase head
 - * rubber belts
 - * capstan
 - * idlers
2. Demagnetize the record/playback head with a head demagnetizer.
3. Do not use a magnetized screwdriver for adjusting.
4. After adjusting, apply a small amount of locking compound to the parts adjusted.
5. The adjustments should be performed in the order arranged in this service manual.
6. The adjustments and measurements should be performed at both L-CH and R-CH with rated power supply voltage unless otherwise specified.
7. The record and the playback level adjustments should be carefully performed. In case the levels are not as specified, DOLBY circuit will not operate correctly.

Test Equipment/Tools Required:

- audio oscillator (af osc)
- VTVM
- digital frequency counter
- oscilloscope
- 1 kHz } bandpass filters
- 5 kHz }
- attenuator (600Ω)
- non-magnetic screwdriver
- blank tape cassette (completely erased with bulk eraser) CS-10, CS-20, CS-30
- resistors 600Ω (¼ W), 10 kΩ (¼ W), 100 kΩ (¼ W)
- SONY test tapes
 - SPC-4 (1 kHz, 0 dB)
 - P-4-L81 (333 Hz, 0 dB)
 - P-4-A82 (10 kHz, -10 dB)

Normal Input Level

	MICROPHONE	LINE IN
impedance	300 Ω	100 kΩ or more
input level	-60 dB (0.77 mV)	-10 dB (0.25 V)

Normal Output Level

	LINE OUT
load impedance	100 kΩ
output level	0 dB (0.775 V)

1. Tape Speed Adjustment

Settings:

- LIMITER switch: OFF
- TAPE SELECT switch: NORMAL
- INPUT SELECT switch: MIC
- MIC ATT switch: 0 dB

Procedure:

1. Mode: Playback

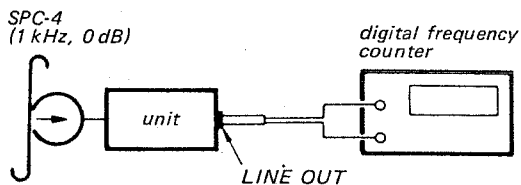

Specification: 985 ~ 1015 Hz

Frequency difference between beginning and end is within 10 Hz.

Adjust	Digital Frequency Counter Reading
R702	1000 Hz

Adjustment Location:

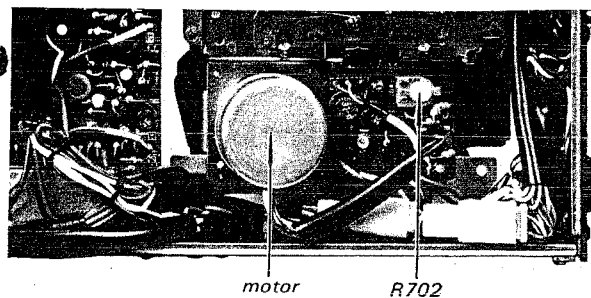

2. Head Azimuth Adjustment

Settings:

- LIMITER switch: OFF
- TAPE SELECT switch: NORMAL
- MIC ATT switch: 0 dB
- INPUT SELECT switch: MIC

Procedure:

1. Mode: Playback

P-4-A82
(10 kHz, -10 dB)

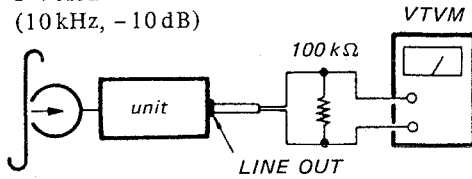

2.

Adjust	VTVM reading	Remarks
azimuth adjusting screw	highest peak	If the highest peak readings at L-CH and R-CH can not be obtained at the same screw position, take the midway between the both positions of the screw.

3. Mode: Playback

P-4-A82
(10 kHz, -10 dB)

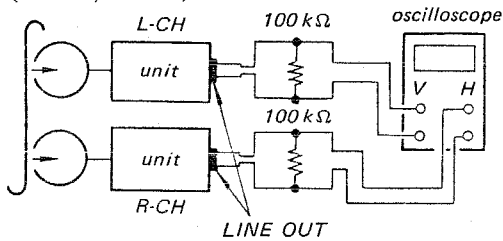

4.

Adjust	Oscilloscope patterns
azimuth adjusting screw to obtain the in-phase pattern	[Allowance] in-phase ~ 90° out of phase

Adjustment Location:

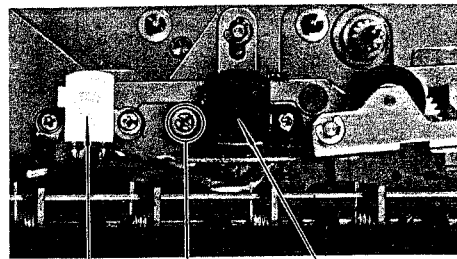

erase head
record/playback head adjustment screw

3. Playback Level Adjustment

Settings:

- LIMITER switch: OFF
- TAPE SELECT switch: NORMAL
- MIC ATT switch: 0 dB
- INPUT SELECT switch: MIC

Procedure:

1. Mode: Playback

P-4-L81
(333 Hz, 0 dB)

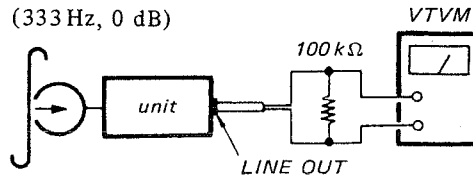

2.

Adjust	VTVM reading	Remarks
R116 (L-CH)	0 dB	1. Allowance: within ±0.5 dB 2. Level difference between the L-CH and R-CH should be within 1 dB.
R216 (R-CH)	(0.775 V)	

Adjustment Location:

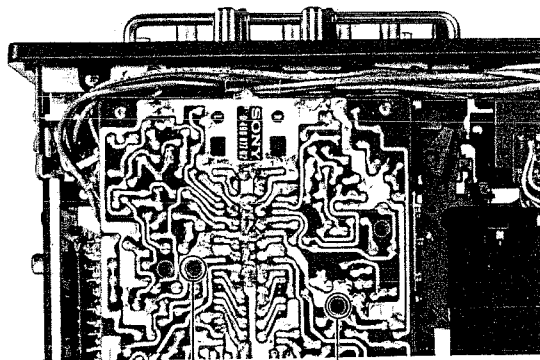

R116 (L) R216 (R)

4. Playback Equalizer Adjustment

Settings:

- LIMITER switch: OFF
- TAPE SELECT switch: NORMAL
- MIC ATT switch: 0 dB
- INPUT SELECT switch: MIC

Procedure:

1. Mode: Playback

P-4-L81
(333 Hz, 0 dB)

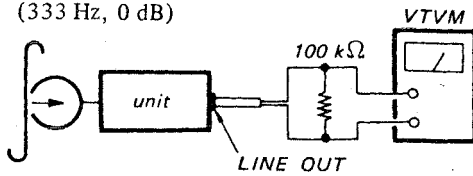

Note the VTVM reading.

2. Mode: Playback

P-4-A81
(6.3 kHz, -10 dB)

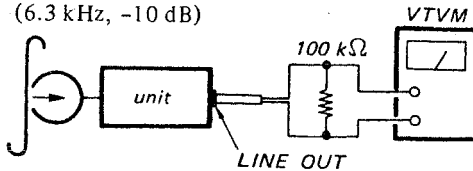

Adjust	VTVM reading	Remarks
R114 (L-CH) R214 (R-CH)	Level in Step 2 is 11 dB lower than level in Step 1.	Allowance: within ±1.5 dB

Note: When adjustable resistors R114 and R214 are turned too much, perform the playback level adjustment on Page 12.

Adjustment Location:

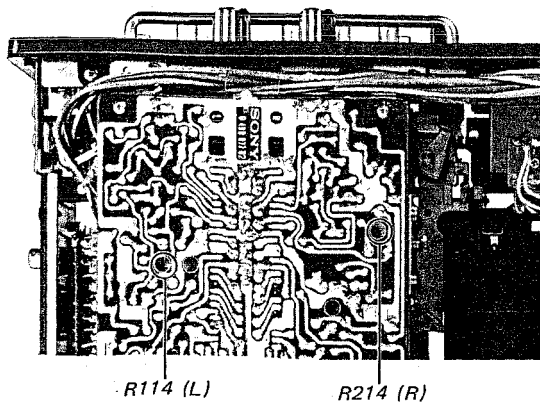

5. LEVEL Meter Calibration

Settings:

- MIC ATT switch: 0 dB
- LIMITER switch: OFF
- INPUT SELECT switch: MIC
- TAPE SELECT switch: NORMAL
- REC VOL control: For 0 dB (0.775 V)
LINE OUT level with 333 Hz, -60 dB (0.77 mV)
MICROPHONE input signal in record mode.

Procedure:

1. Mode: Record

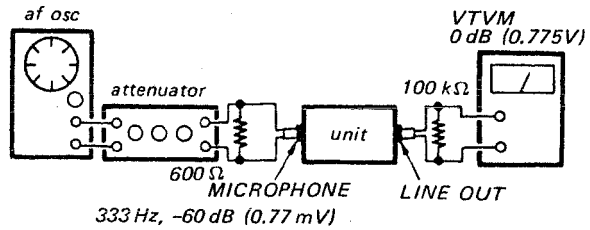

2.

Adjust	LEVEL meter reading: 0 VU
R134 (L-CH) R234 (R-CH)	

Adjustment Location:

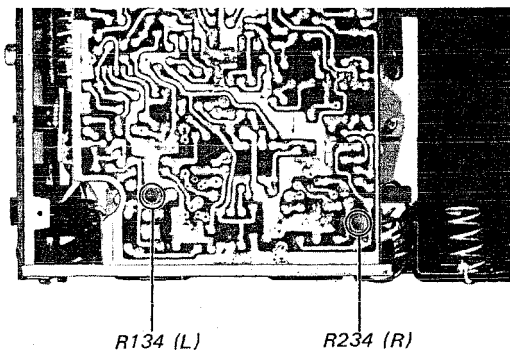

6. Record Bias Adjustment

Adjustment Location:

Settings:

- LIMITER switch: OFF
- INPUT SELECT switch: MIC
- TAPE SELECT switch: NORMAL
- MIC ATT switch: 0 dB
- REC VOL control: For 0 dB (0.775 V)
LINE OUT level with
333 Hz, -60 dB (0.77 mV)
MICROPHONE input
signal in record mode.

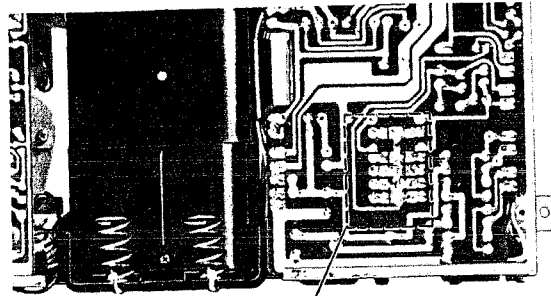

Procedure:

1. Mode: Record

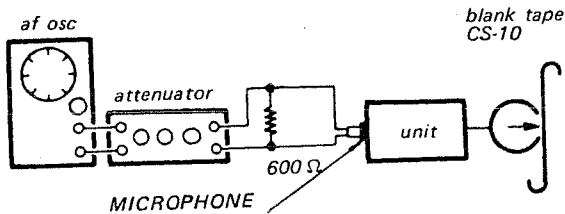

- (1) 1 kHz, -100 dB (8 μV)
- (2) 10 kHz, -100 dB (8 μV)

2. Mode: Playback

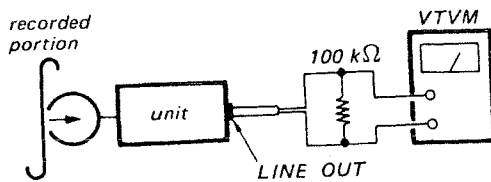

Adjust	VTVM reading
C161 (L-CH) C261 (R-CH)	1 kHz level = 10 kHz level Allowance: within ±1 dB

Level	Capacitance Value
10 kHz > 1 kHz	increase
10 kHz < 1 kHz	decrease

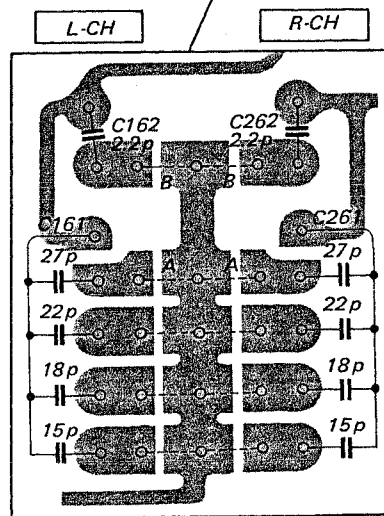

Adjust capacitance values with connecting the patterns as shown by the dotted lines A and repeat steps 1 and 2. When fine adjustment is necessary, use C162 and C262 (2.2 pF) with connecting the patterns as shown by the dotted lines B.

7. Record Level Adjustment

Settings:

- LIMITER switch: OFF
- TAPE SELECT switch: NORMAL
- INPUT SELECT switch: MIC
- MIC ATT switch: 0 dB
- REC VOL control: For 0 dB (0.775 V)
LINE OUT level with
333 Hz, -60 dB (0.77 mV)
MICROPHONE input
signal in record mode.

Procedure:

1. Mode: Record

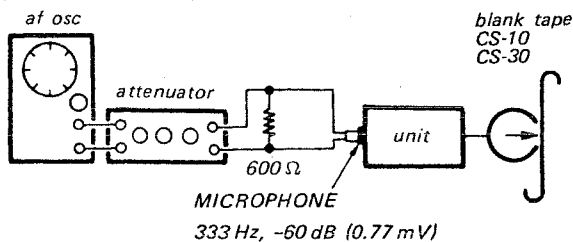

2. Mode: Playback

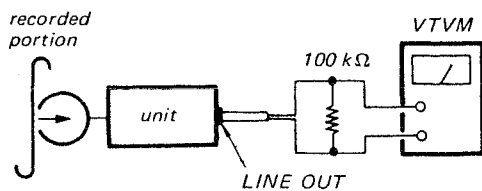

Adjust	VTVM reading	Remarks
R151 (L-CH)	0 dB (0.775 V)	Allowance: ±0.5 dB (CS-10, TAPE SELECT switch NORMAL) ±2 dB (CS-30, TAPE SELECT switch FeCr)
R251 (R-CH)		

Adjustment Location:

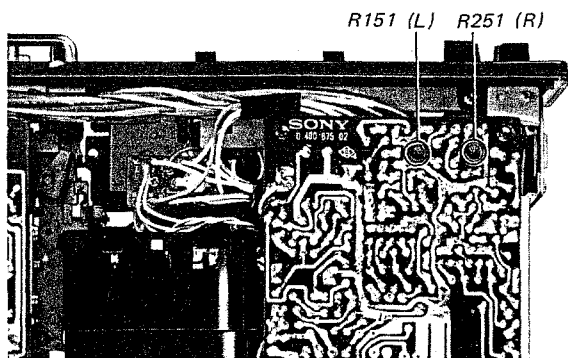

8. 19 kHz Filter Measurement

Settings:

- MIC ATT switch: 0 dB
- LIMITER switch: OFF
- INPUT SELECT switch: MIC
- TAPE SELECT switch: NORMAL
- REC VOL control: For 0 dB (0.775 V)
LINE OUT level with
333 Hz, -60 dB (0.77 mV)
MICROPHONE input
signal in record mode.

Procedure:

1. Mode: Record

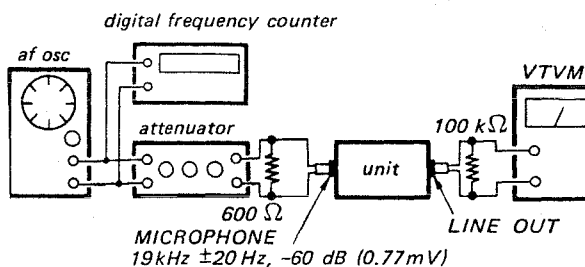

Note: 19 kHz pilot signal of stereo signal generator may be used for input signal.

Specification:

-28 dB (31 mV) or less.

9. Overall Signal-to-Noise Ratio Measurement

Settings:

- LIMITER switch: OFF
- TAPE SELECT switch: NORMAL
- INPUT SELECT switch: MIC
- MIC ATT switch: 0 dB
- REC VOL control: for 0 dB (0.775 V)
LINE OUT level with
333 Hz, -60 dB (0.77 mV)
MICROPHONE input
signal in record mode.

Procedure:

1. Mode: Record

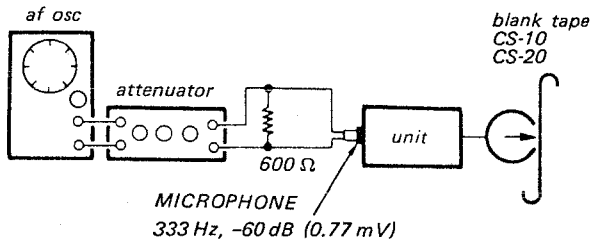

2. Mode: Record

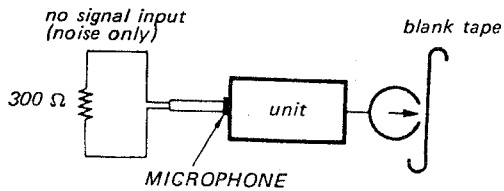

3. Mode: Playback

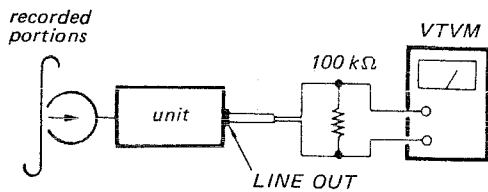

Playback	VTVM reading
333 Hz	level difference: greater than 43 dB (CS-10, TAPE SELECT switch ... NORMAL) greater than 44 dB (CS-20, TAPE SELECT switch ... CrO ₂)
no signal	

10. Overall Frequency Response Measurement

Settings:

- LIMITER switch: OFF
- TAPE SELECT switch: NORMAL
- INPUT SELECT switch: MIC
- MIC ATT switch: 0 dB
- REC VOL control: For 0 dB (0.775 V)
LINE OUT level with
333 Hz, -60 dB (0.77 mV)
MICROPHONE input
signal in record mode.

Procedure:

1. Mode: Record

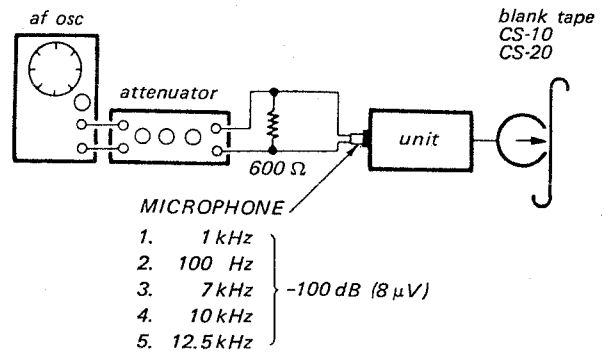

2. Mode: Playback

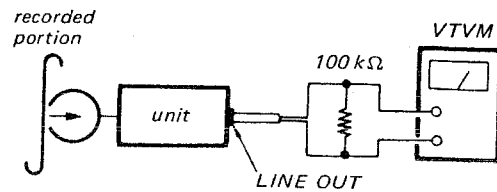

Playback	Output level difference from 1 kHz level	
	DOLBY NR switch: OFF	
	TAPE: CS-20 TAPE SELECT switch: CrO ₂	TAPE: CS-10 TAPE SELECT switch: NORMAL
1 kHz	0 dB (reference)	0 dB (reference)
100 Hz	±3 dB	±3 dB
7 kHz	±3 dB	±2 dB
10 kHz	±3 dB	±2 dB
12.5 kHz	±3 dB	±1 3/3 dB

11. LIMITER Response Measurement

Settings:

- LIMITER switch: ON
- TAPE SELECT switch: NORMAL
- INPUT SELECT switch: MIC
- MIC ATT switch: 0 dB
- REC VOL control: For 0 dB (0.775 V)
LINE OUT level with
333 Hz, -60 dB (0.77 mV)
MICROPHONE input
signal in record mode.

Procedure:

1. Mode: Record

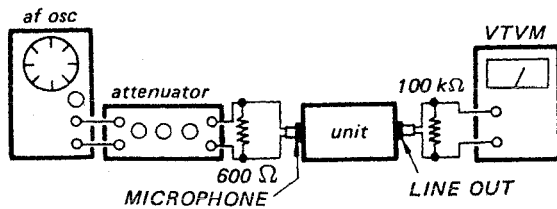

1. 333 Hz, -60 dB (0.77 mV)
2. 333 Hz, -30 dB (25 mV)

Input signal	VTVM reading
333 Hz, -60 dB (0.77 mV)	-0.5 dB (0.73 V) ±0.5 dB
333 Hz, -30 dB (25 mV)	+4.5 dB (1.3 V) ±1.5 dB

12. DOLBY System Noise Reduction Measurement

Settings:

- INPUT SELECT switch: MIC
- LIMITER switch: OFF
- TAPE SELECT switch: NORMAL
- MIC ATT switch: 0 dB
- REC VOL control: MIN

Procedure:

1. Set DOLBY NR switch to OFF position.
2. Mode: Record

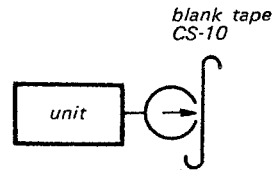

3. Mode: Playback

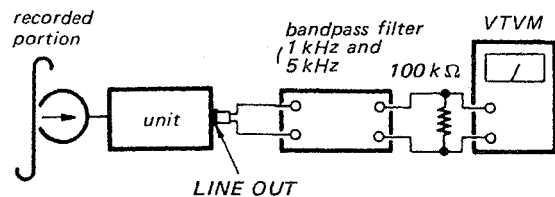

Note the VTVM reading.

4. Set DOLBY NR switch to ON position, perform Steps 2 and 3.
5. Make sure that the level difference between the step 3) and step 4) is as specified.

Note: Make sure that DOLBY system improves noise level.

Specification:

- 4 dB or more at 1 kHz
- 8 dB or more at 5 kHz

13. Erase Ratio Measurement

Settings:

- LIMITER switch: OFF
- TAPE SELECT switch: CrO₂
- INPUT SELECT switch: MIC
- MIC ATT switch: 0 dB
- REC VOL control: For 0 dB (0.775 V)
LINE OUT level with
333 Hz, -60 dB (0.77 mV)
MICROPHONE input
signal in record mode.

Procedure:

1. Mode: Record

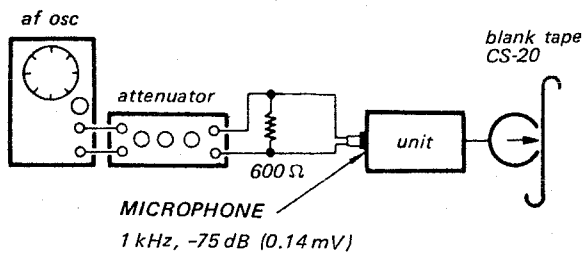

2. Rewind half of recorded portion.
3. Set REC VOL control to MIN position.
4. Mode: Record
no signal input (erase)

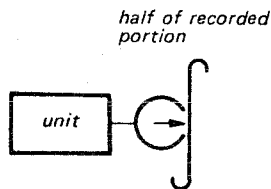

5. Mode: Playback

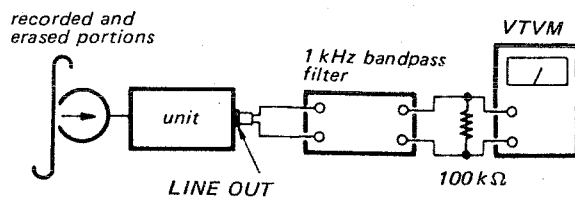

Playback	VTVM reading
1 kHz	level difference: greater than 60 dB
erased portion	

14. Cross Talk Measurement (between channels)

Settings:

- LIMITER switch: OFF
- TAPE SELECT switch: NORMAL
- INPUT SELECT switch: MIC
- MIC ATT switch: 0 dB
- R-CH REC VOL control: For 0 dB (0.775 V)
LINE OUT level with
333 Hz, -60 dB (0.77 mV)
MICROPHONE input
signal in record mode.

Procedure:

1. Set L-CH REC VOL control to the same position as R-CH REC VOL control.
2. Terminate L-CH MICROPHONE jack with 300 Ω resistor.

3. Mode: Record

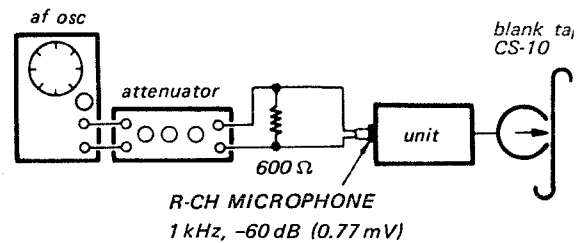

4. Mode: Playback

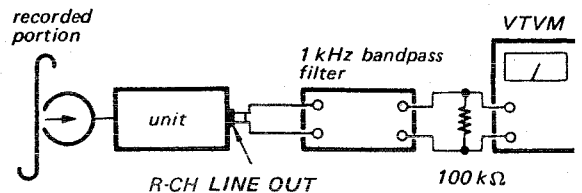

Playback	VTVM reading
R-CH (1 kHz)	level difference: greater than 25 dB
L-CH (no signal)	

15. Cross Talk Measurement (between tracks)

Settings:

- LIMITER switch: OFF
- TAPE SELECT switch: NORMAL
- INPUT SELECT switch: MIC
- MIC ATT switch: 0 dB
- R-CH REC VOL control: For 0 dB (0.775 V) LINE OUT level with 333 Hz, -60 dB (0.77 mV) MICROPHONE input signal in record mode.

Procedure:

1. Set L-CH REC VOL control to the same position as the R-CH REC VOL control.
2. Terminate L-CH MICROPHONE jack with 300 Ω resistor.
3. Mode: Record

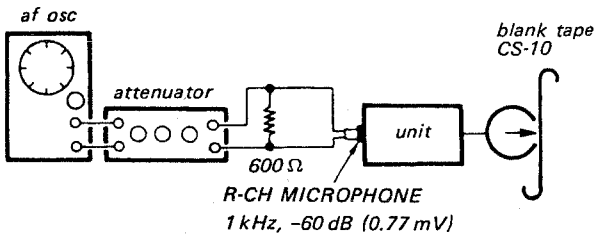

4. Mode: Playback

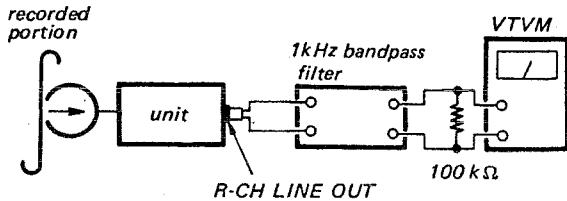

5. Turn the cassette over.

6. Mode: Playback

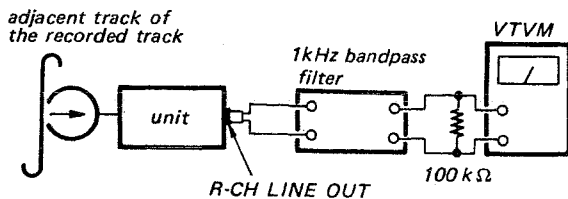

Playback	VTVM reading
1 kHz	level difference: greater than 60 dB
adjacent track of the recorded track	

16. BATTERY CHECK Calibration

Settings:

- Forward lever: depressed
- External Dc Power Supply: 4.4 V DC regulated

Procedure:

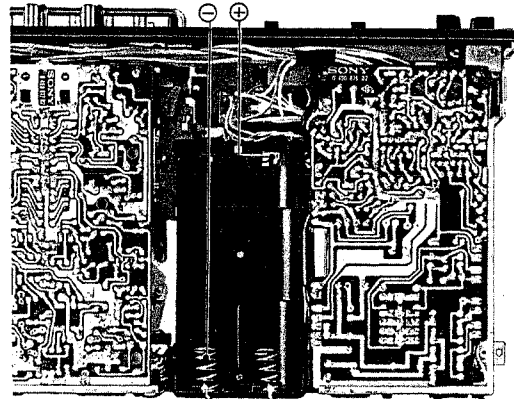
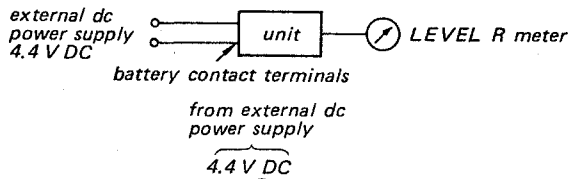

Press BATTERY CHECK button and adjust R901 so that the pointer of LEVEL R meter places right on the leftmost edge of the white mark.

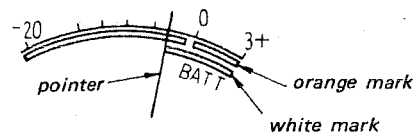

Adjustment Location:

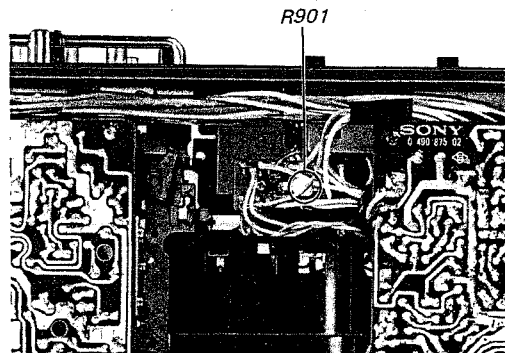

4-1. MOUNTING DIAGRAMS

SECTION 4
DIAGRAMS

- Conductor Side -

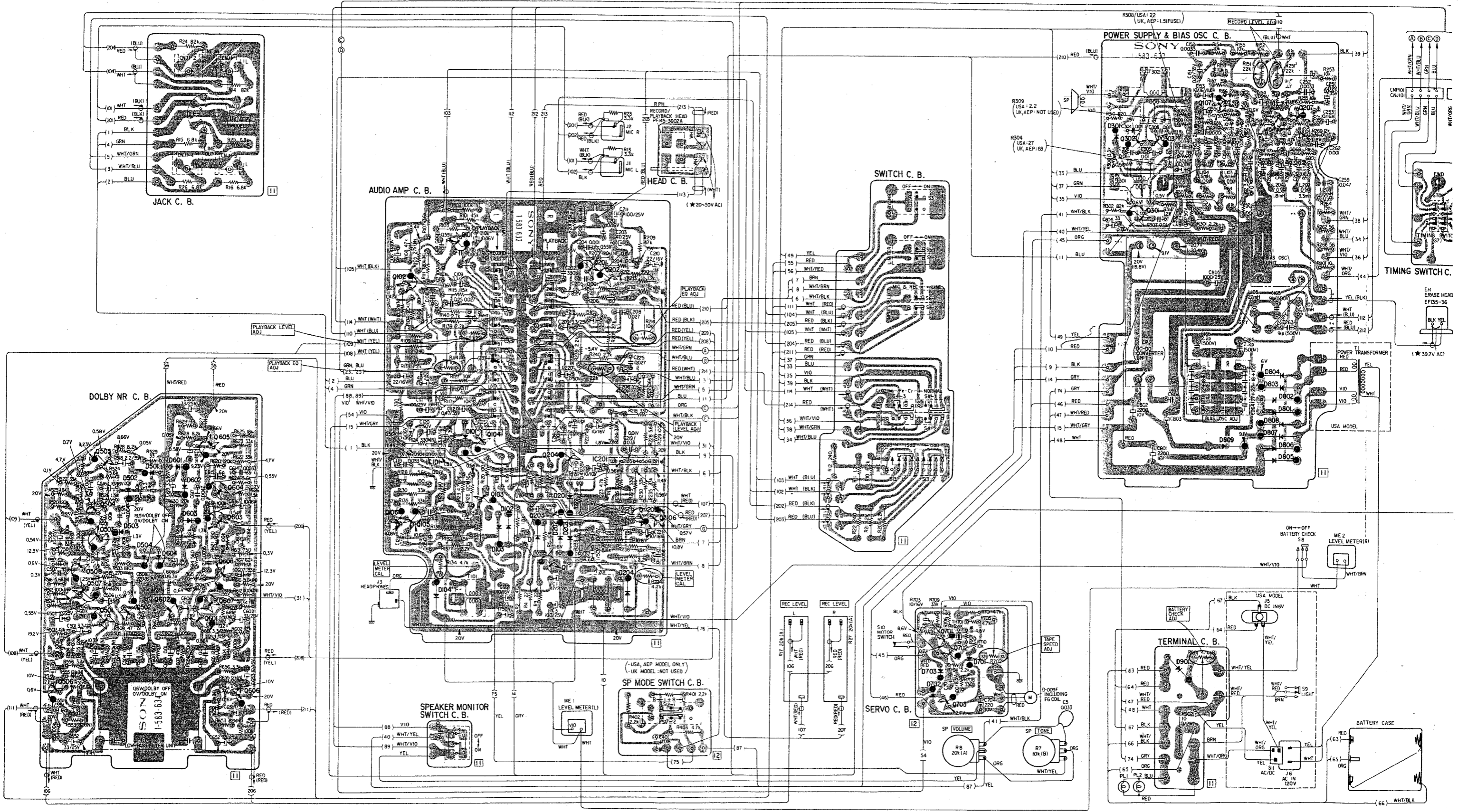

Q, IC	506	508	505,504,503	502	602	605,604,603,608	601,607	606	102 IC101	101	104	203	204	201	202 IC201	205	206	701	702,703	701	302	303	107	207	Q, IC
D			502	501	601,602				106	105	103			201	204			702,703	701	301	301	901	809	801-808	D

TC-153SD TC-153SD

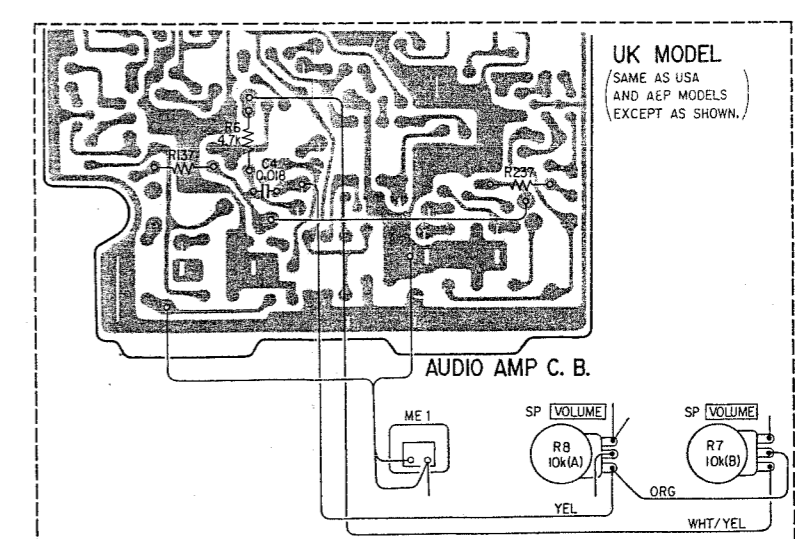
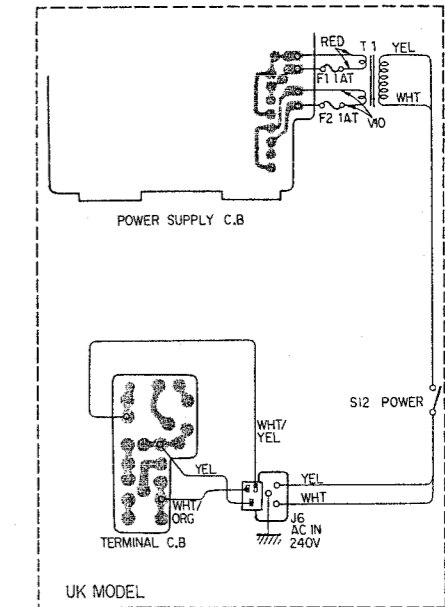
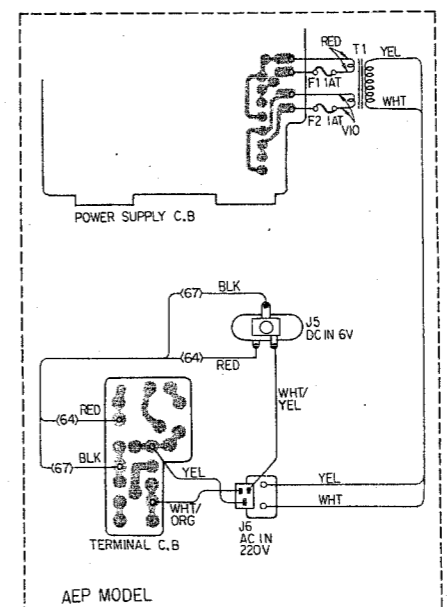
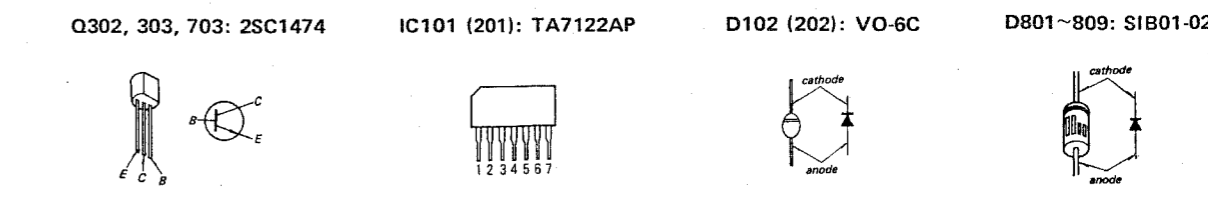
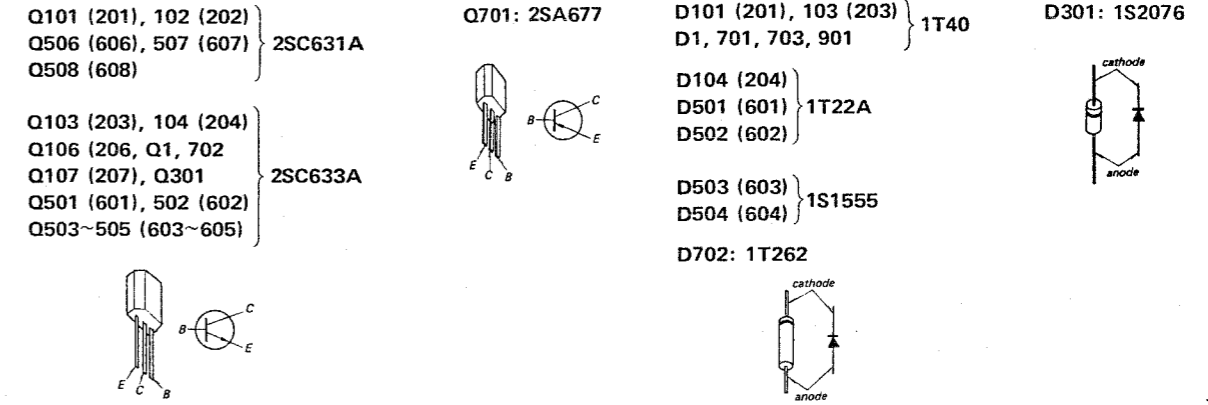
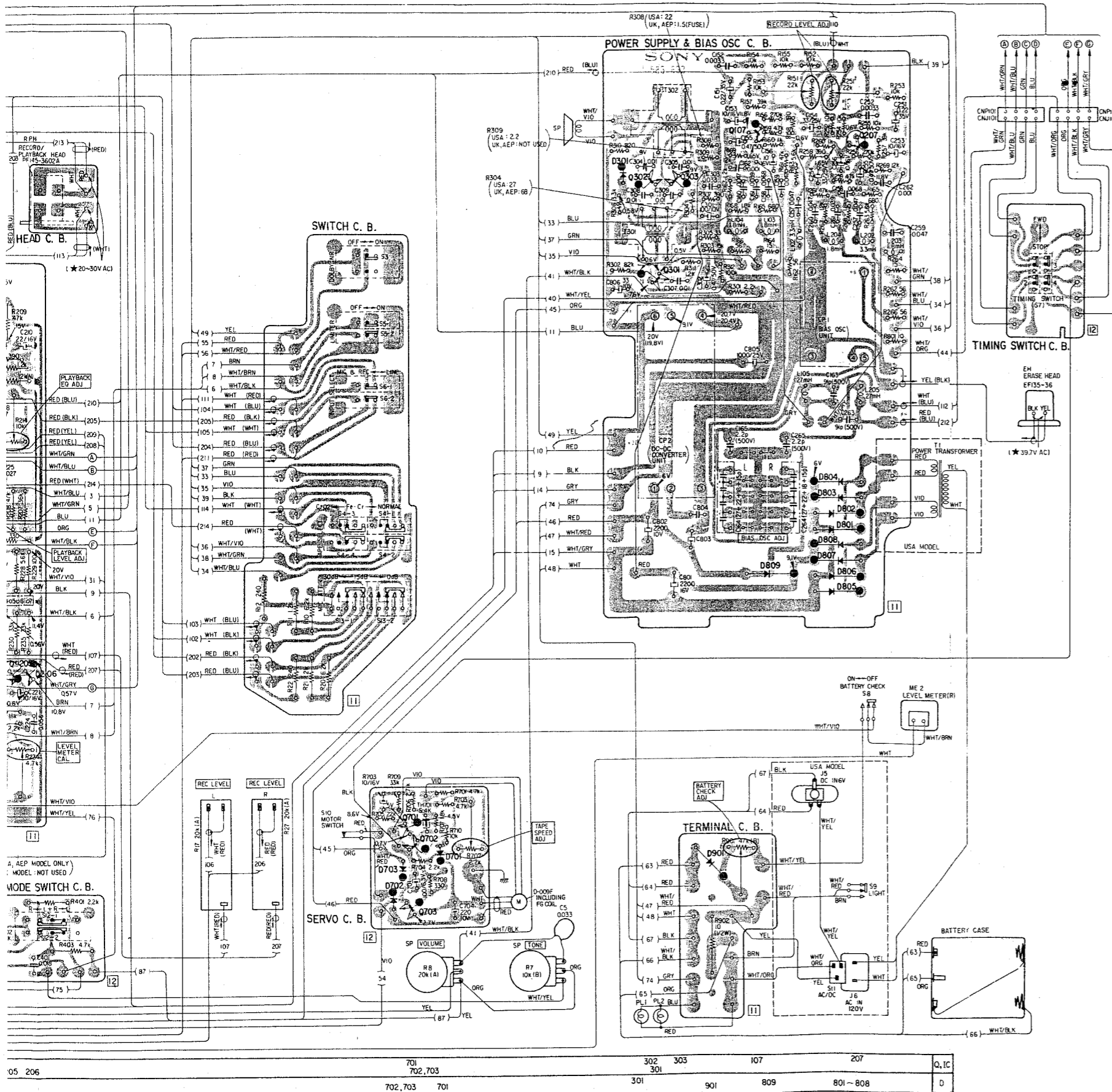

05 206	701	702, 703	302	303	107	207	Q, IC
	702, 703	701	301	301	901	809	D
						801-808	

4-2. SCHEMATIC DIAGRAM

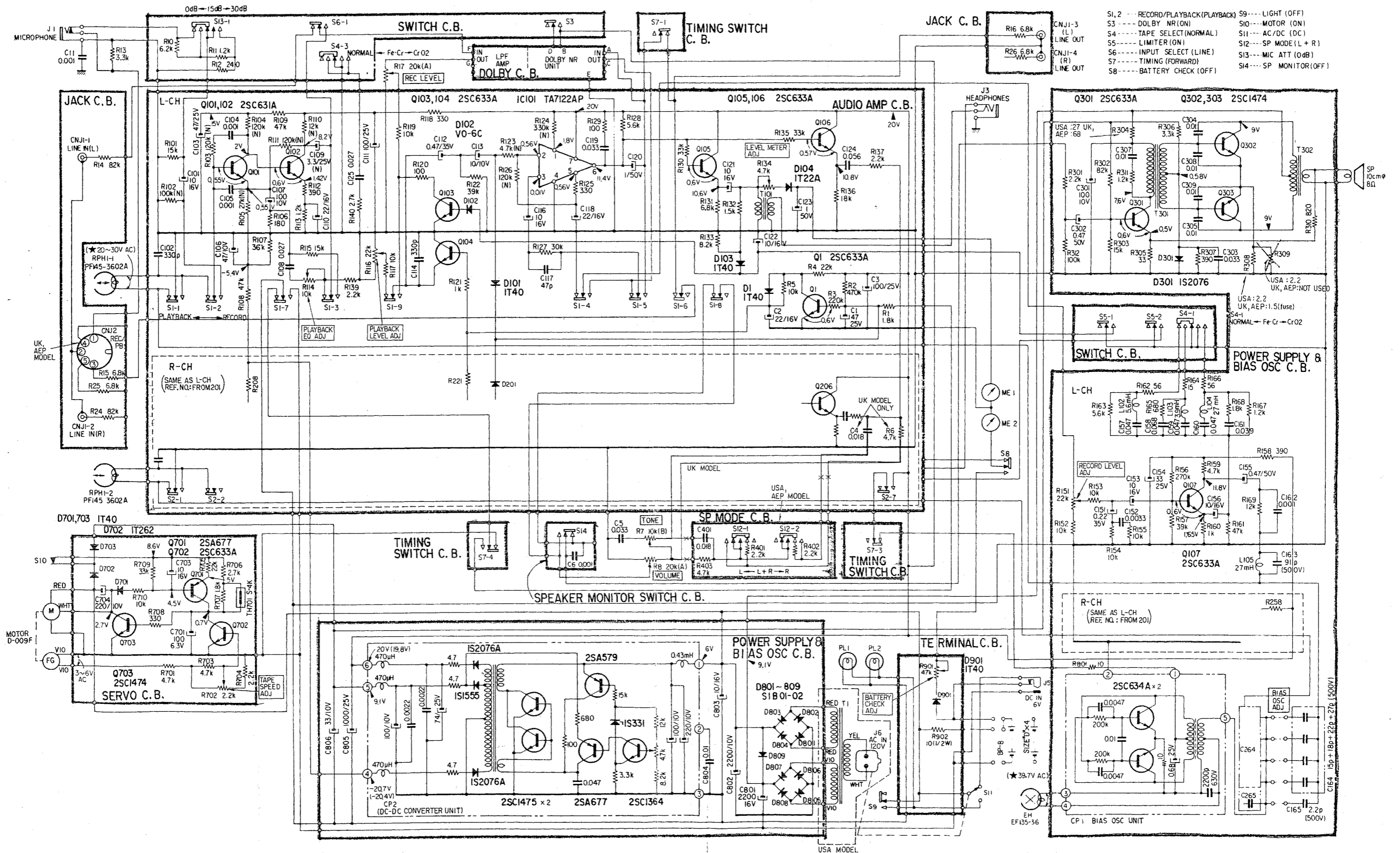

- S1, 2 --- RECORD/PLAYBACK (PLAYBACK)
- S3 --- DOLBY NR (ON)
- S4 --- TAPE SELECT (NORMAL)
- S5 --- LIMITER (ON)
- S6 --- INPUT SELECT (LINE)
- S7 --- TIMING (FORWARD)
- S8 --- BATTERY CHECK (OFF)
- S9 --- LIGHT (OFF)
- S10 --- MOTOR (ON)
- S11 --- AC/DC (DC)
- S12 --- SP MODE (L + R)
- S13 --- MIC ATT (0dB)
- S14 --- SP MONITOR (OFF)

CORRECTION

Subject: File this correction with service manual

Sep

Change the Dolby circuit diagram on page 25 of the manual to the following diagram.

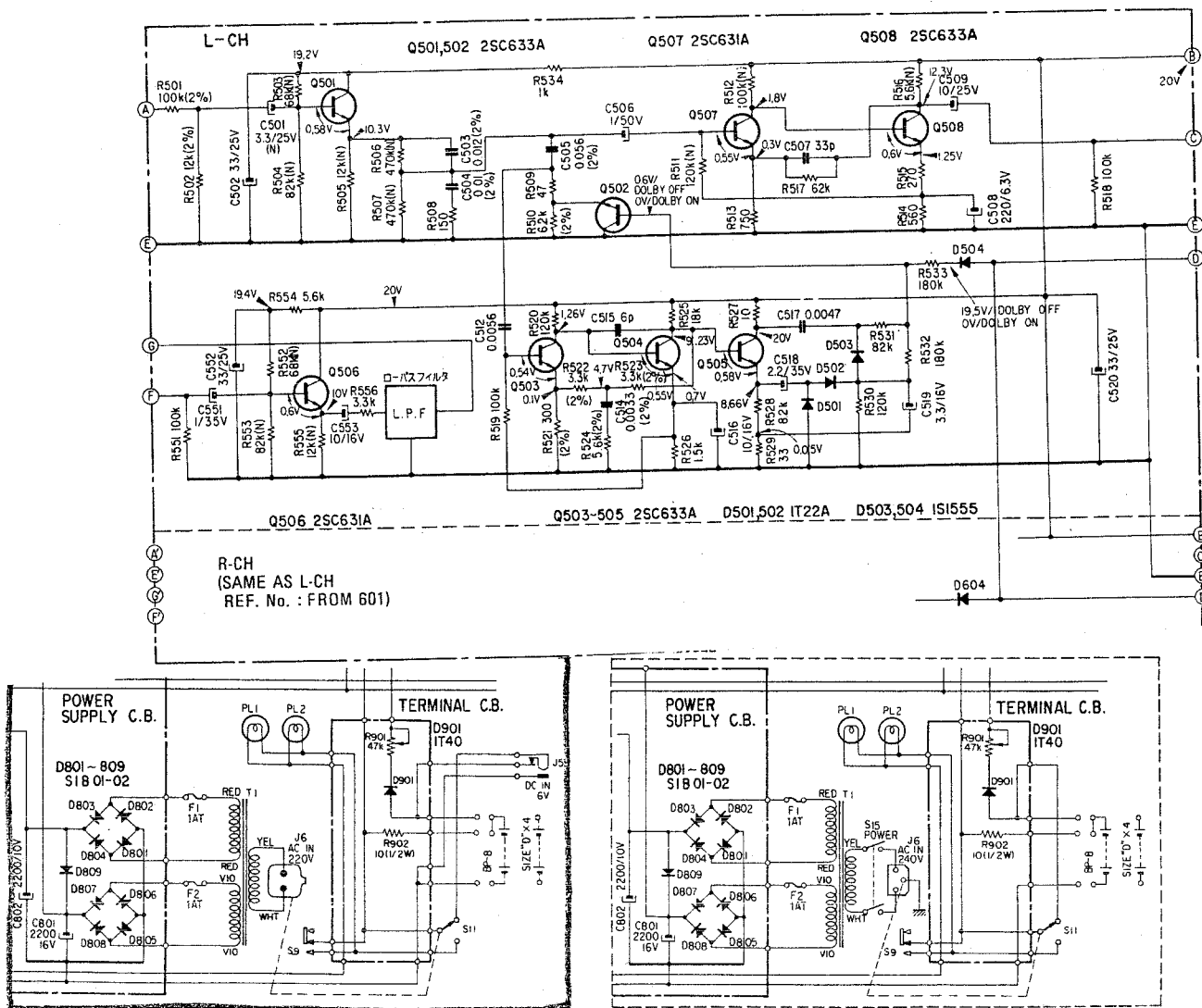

Note:

- All capacitors are in μF unless otherwise noted. $\text{p} = \mu\text{F}$
- All resistors are in Ω , $\frac{1}{4}\text{W}$, unless otherwise noted. $\text{k} = 1,000$ $\text{M} = 1,000\text{k}$
- Circuit shown with red colour.
- (N) indicates a low-noise resistor.
- C.B. : Circuit Board is for the UK and NEP models.
- Voltages are DC with respect to ground unless otherwise noted. Readings taken under no-signal conditions with a VOM (20 $\text{k}\Omega/\text{V}$). Readings in () are in record mode. Voltage variations may be noted due to normal production tolerances.

- AC voltage readings on bias oscillator circuit taken with a VTVM.
- When replacing resistors and capacitors needing $\pm 2\%$ tolerance, use only those with red line or G mark, as DOLBY system requires precise circuit operation.

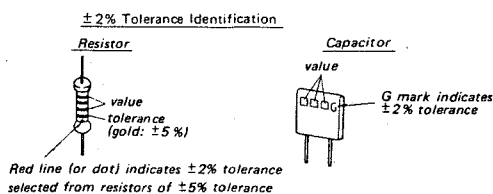

4-3. LEVEL DIAGRAMS

— Record Mode —

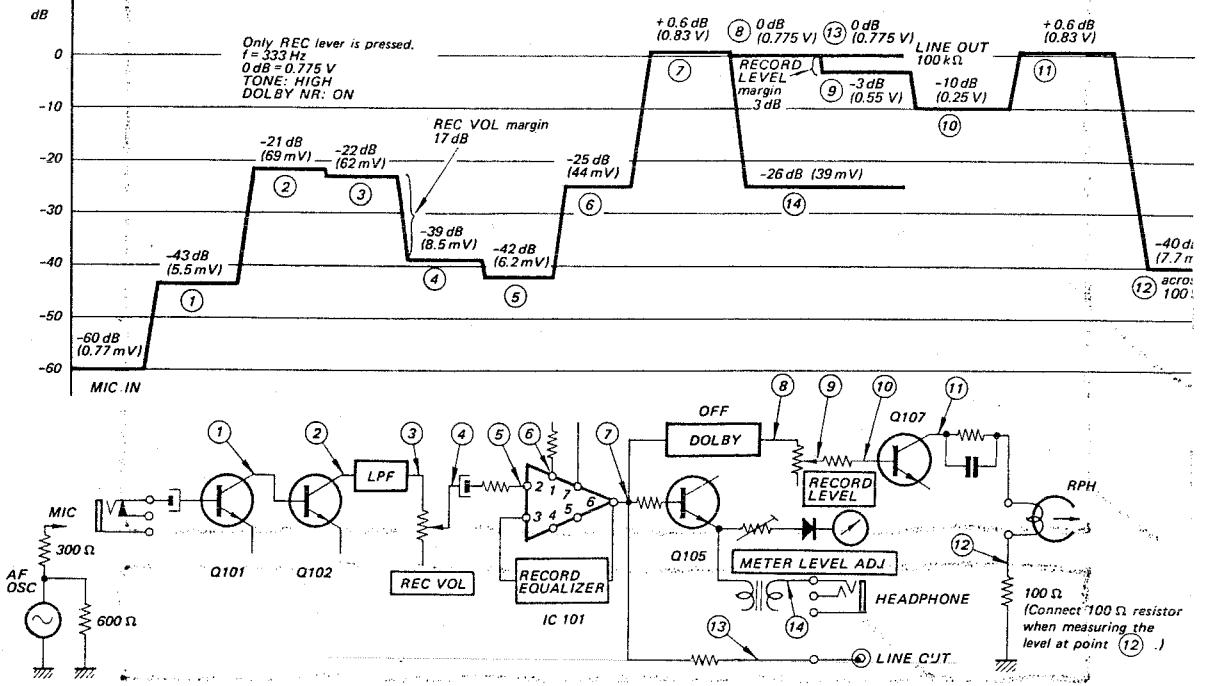

— Playback Mode —

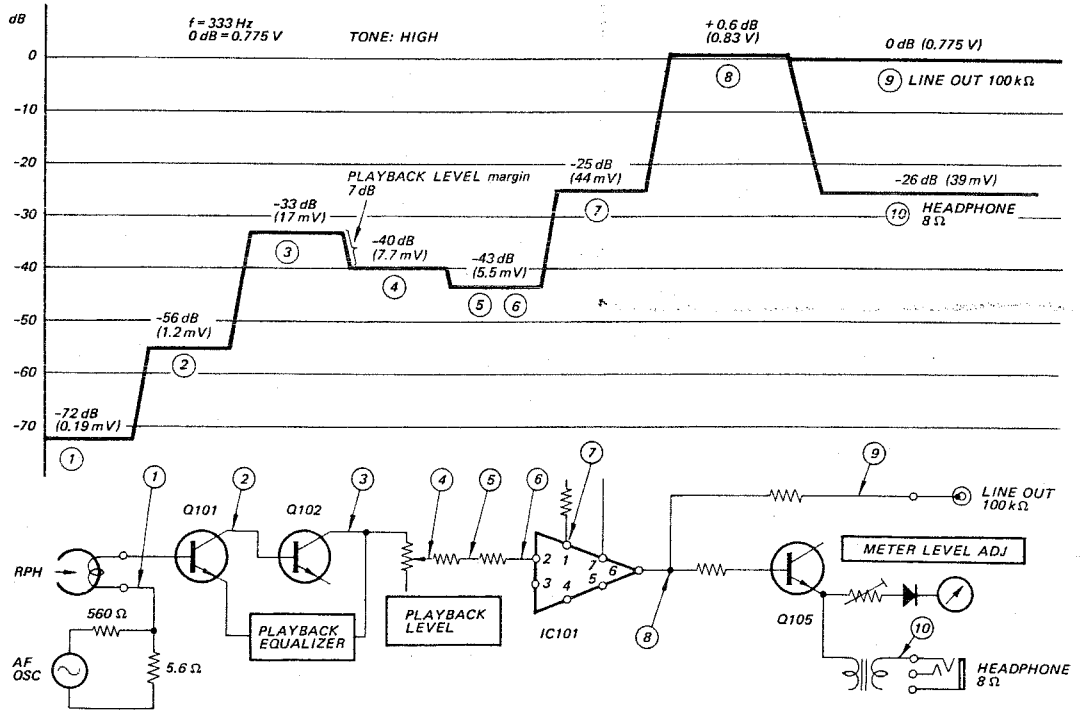

tel
tel
tel

1976

WH (109)
(TI)
0.
12
0.
0.55
19.2
WH (108)
WHT (YEL)
10V-
0.6V-

WH (111)
WHT (RED)

NY

Q. IC
D

MANUAL

78G0606-3
Printed in Japan

— Amplifier Mode —

Only the REC lever is pressed

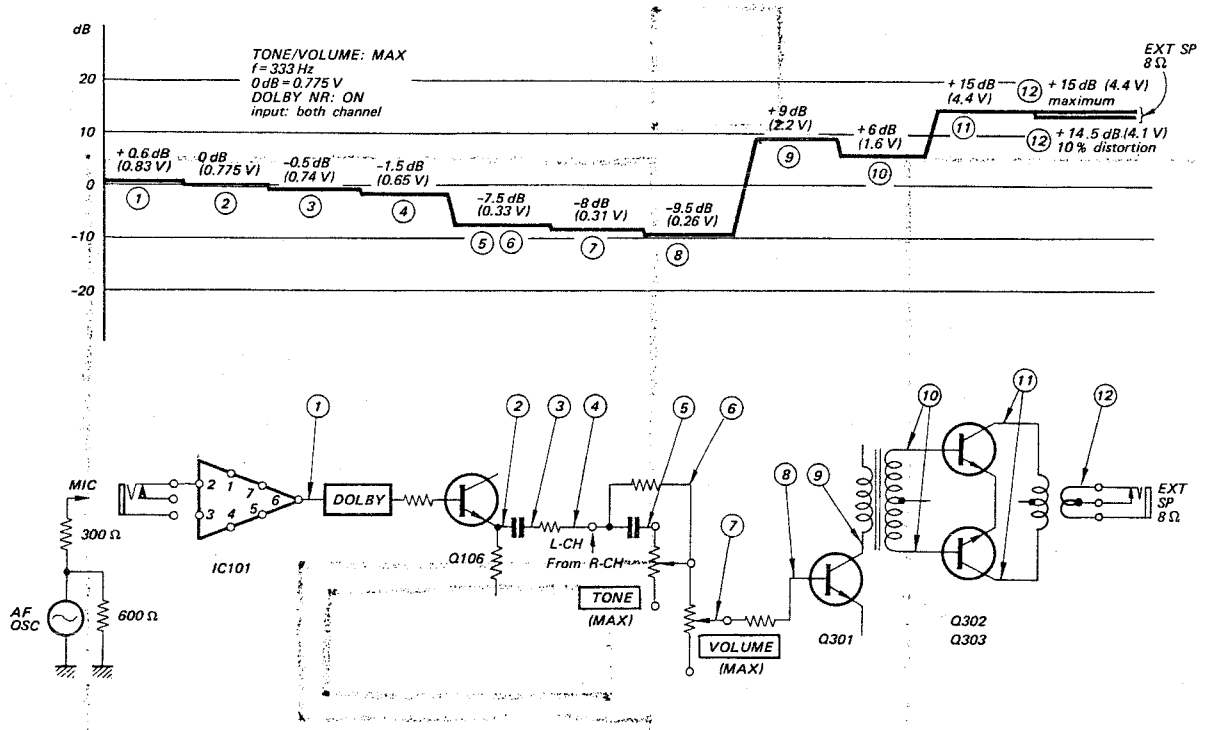

**SECTION 5
EXPLODED VIEWS**

5-1. EXPLODED VIEW (1)

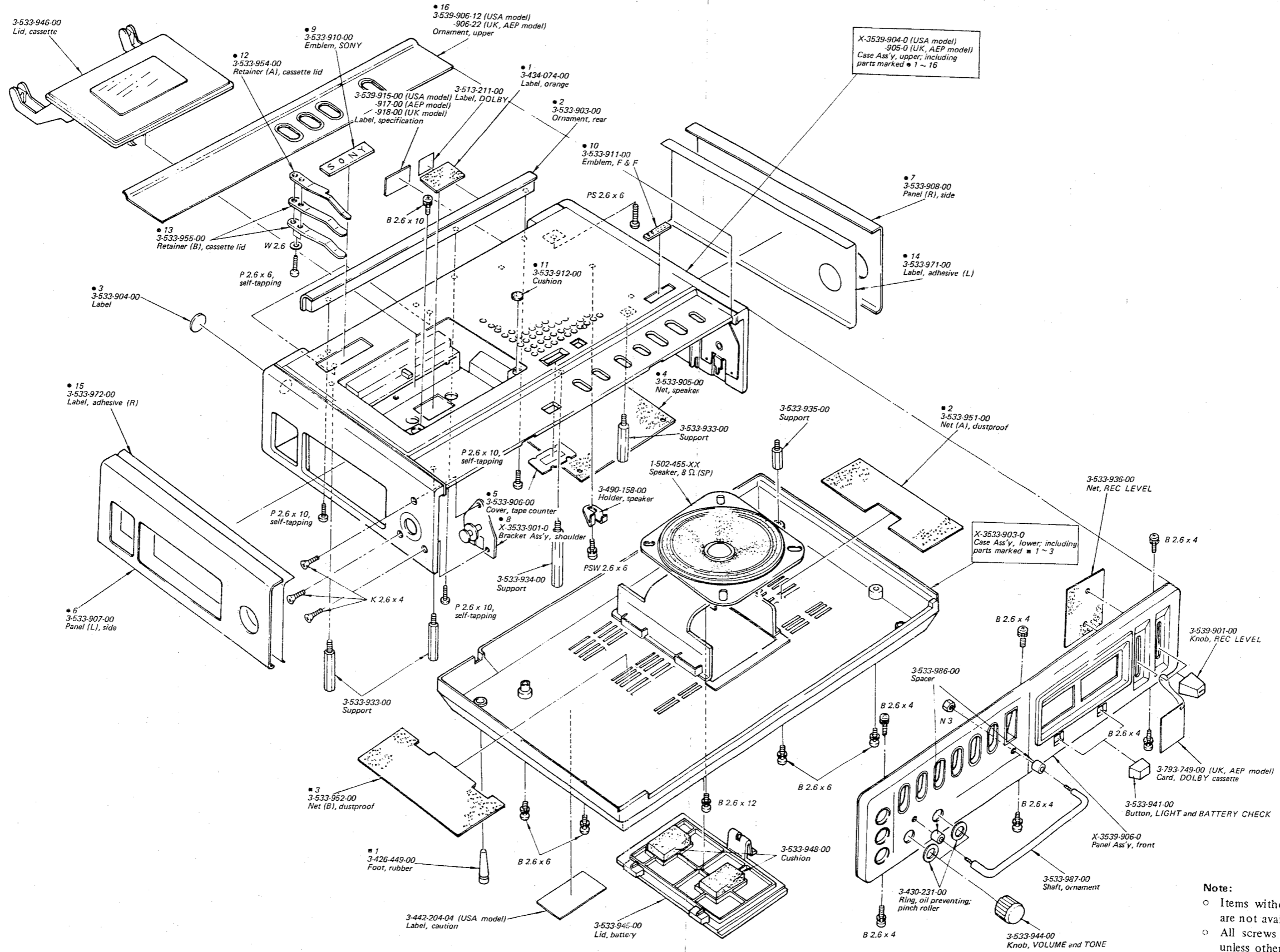

Note:

- Items without part number and description are not available.
- All screws are Phillips (cross recess) type unless otherwise noted.
- (-) = slotted head

5-4. EXPLODED VIEW (4)

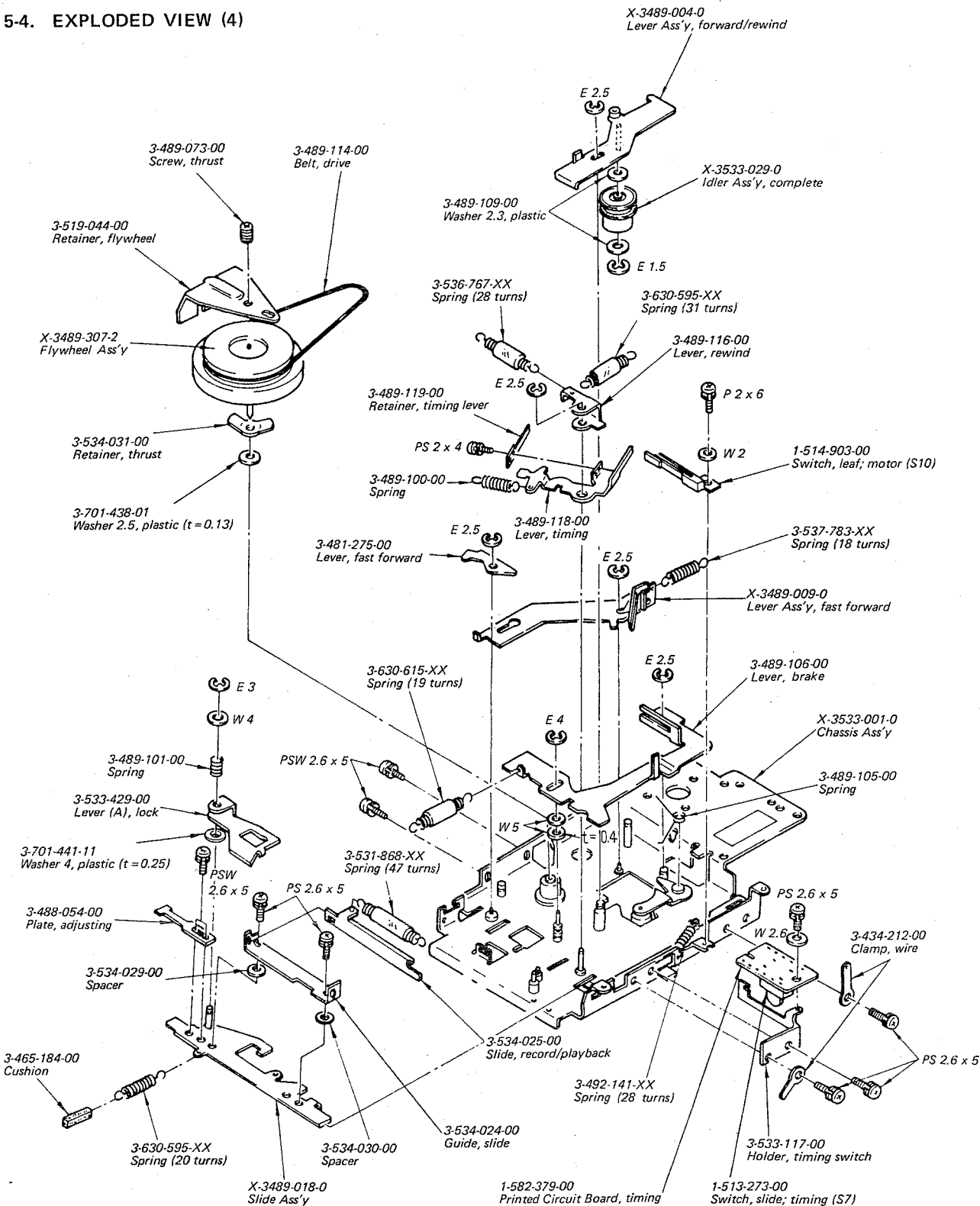

Note:

- Items without part number and description are not available.
- All screws are Phillips (cross recess) type unless otherwise noted.
- (-) = slotted head

5-5. EXPLODED VIEW (5)

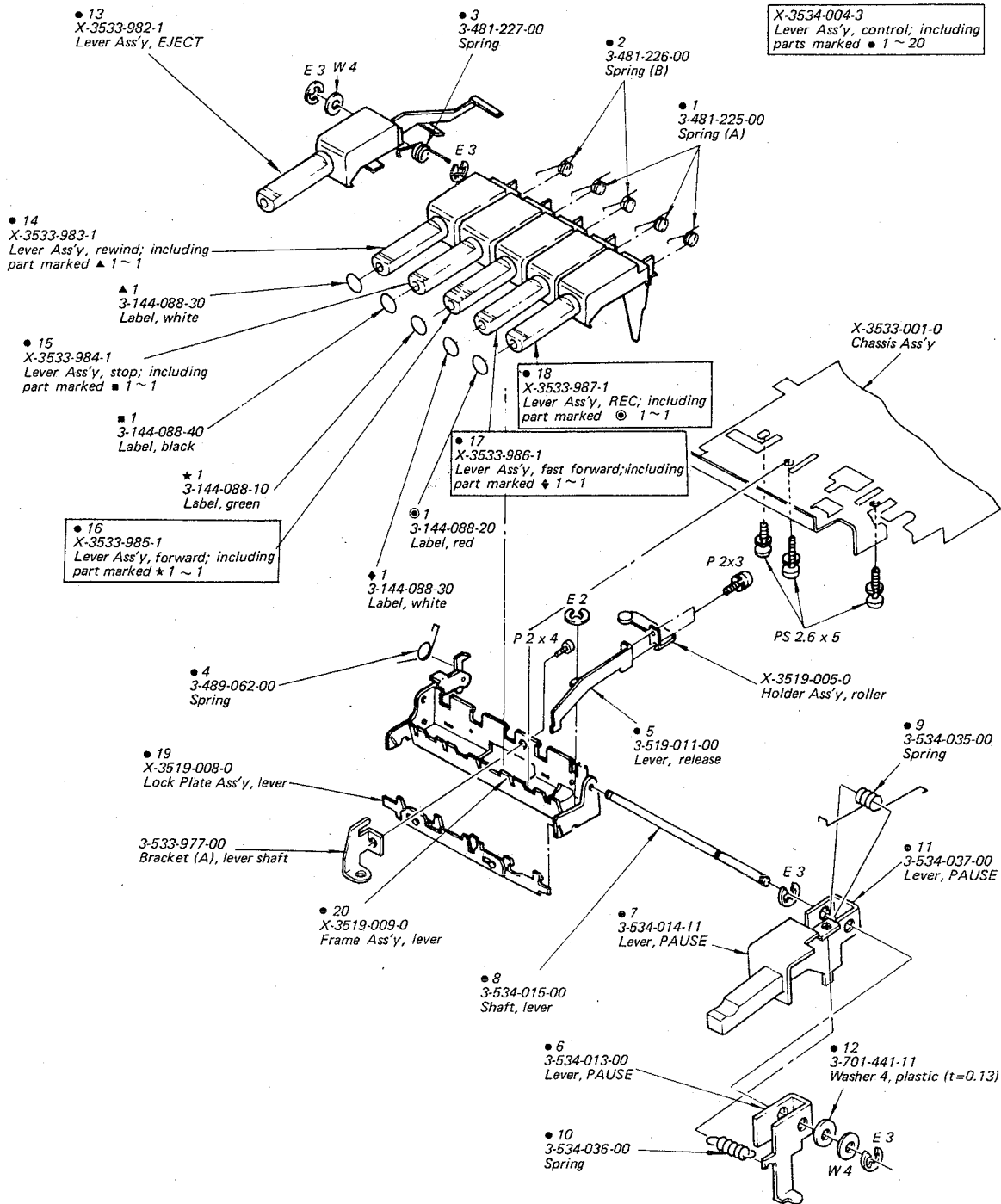

Note:

- Items without part number and description are not available.
- All screws are Phillips (cross recess) type unless otherwise noted.
- (-) = slotted head

SECTION 6 ELECTRICAL PARTS LIST

<u>Ref. No.</u>	<u>Part No.</u>	<u>Description</u>	<u>Ref. No.</u>	<u>Part No.</u>	<u>Description</u>
COMPLETE CIRCUIT BOARDS			Q701		2SA677
	A-2010-005-A	Audio Amp (USA, AEP model)	Q702		2SC633A
	A-2010-019-A	Audio Amp (UK model)	Q703		2SC1474
	A-2012-005-A	Power Supply & Bias Osc (USA model)	IC101,201		TA7122AP
	A-2012-030-A	Power Supply & Bias Osc (UK, AEP model)	Diodes		
	A-2023-009-A	Switch (DOLBY NR/LIMITER/ INPUT SELECT/TAPE SELECT/ MIC ATT)	D1		1T40
	A-2023-010-A	SP MONITOR switch	D101,201		1T40
	A-2025-005-A	Jack (UK, AEP model)	D102,202		VO6C
	A-2025-018-A	Jack (USA model)	D103,203		1T40
	A-2030-001-A	DOLBY NR	D104,204		1T22
	A-2095-018-A	Terminal	D301		1S2076
	X-3533-915-0	SP MODE switch (USA, AEP model)	D501,601		1T22
	X-3534-006-1	Servo amp	502,602		
			D503,603		1S1555
			504,604		
			D701		1T40
			D702		1T262
			D703		1T40
			D801~809		SIB01-02
			D901		1T40
PRINTED CIRCUIT BOARDS			COILS		
	1-582-379-00	Timing	L102,202	1-407-203-XX	5.6 mH, microinductor
	1-582-558-00	Record/Playback head	L103,203	1-407-201-XX	3.9 mH, microinductor
			L104,204	1-407-593-00	27 mH, microinductor
SEMICONDUCTORS			TRANSFORMERS		
		Transistors	T1	1-442-449-11	Power (AEP model)
Q1		2SC633A	T1	1-442-450-11	Power (UK model)
Q101,201		2SC631A	T1	1-442-455-11	Power (USA model)
102,202			T101,201	1-427-299-00	Headphones
Q103~107		2SC633A	T301	1-423-049-00	Driver
203~207			T302	1-427-343-00	Output
Q301		2SC633A	Th701	1-800-200-00	Thermistor, S-4K
Q302,303		2SC1474			
Q501~505		2SC633A			
601~605					
Q506,606		2SC631A			
507,607					
Q508,608		2SC633A			

Ref. No. Part No. Description

CAPACITORS

All capacitors are in μF unless otherwise indicated.
50 or less working volts are omitted except for
electrolytic type (elect = electrolytic, p= μF).

C1	1-121-410-11	47	25V	elect
C2	1-121-479-11	22	16V	elect
C3	1-121-416-11	100	25V	elect
C4	1-108-358-11	0.018		mylar (UK model)
C5	1-105-679-12	0.033		mylar
C11,12	1-101-455-11	0.001		ceramic
C101,201	1-121-651-11	10	16V	elect
C102,202	1-102-112-11	330p		ceramic
C103,203	1-121-410-11	47	25V	elect
C104,204	1-105-661-12	0.001		mylar
105,205				
C106,206	1-121-352-11	47	10V	elect
C107,207	1-121-414-11	100	10V	elect
C108,208	1-105-518-12	0.027		mylar
C109,209	1-121-913-11	3.3	25V	elect
C110,210	1-121-479-11	22	16V	elect
C111,211	1-121-416-11	100	25V	elect
C112,212	1-131-213-11	0.47		solid tantalum
C113,213	1-131-193-11	10		solid tantalum
C114,214	1-102-112-11	330p		ceramic
C116,216	1-121-651-11	10	16V	elect
C117,217	1-107-123-11	47p		silvered mica
C118,218	1-121-479-11	22	16V	elect
C119,219	1-105-679-12	0.033		mylar
C120,220	1-121-391-11	1	50V	elect
C121,221	1-121-651-11	10	16V	elect
122,222				
C123,223	1-121-391-11	1	50V	elect
C124,224	1-105-682-12	0.056		mylar
C125,225	1-105-518-12	0.027		mylar
C151,251	1-131-211-11	0.22		solid tantalum
C152,252	1-105-667-12	0.0033		mylar
C153,253	1-121-651-11	10	16V	elect
C154,254	1-121-404-11	33	25V	elect
C155,255	1-121-726-11	0.47	50V	elect
C156,256	1-121-651-11	10	16V	elect

Ref. No. Part No. Description

C157,257	1-105-521-12	0.047		mylar
C158,258	1-105-523-12	0.068		mylar
C159,259	1-105-521-12	0.047		mylar
160,260				
C161,261	1-105-520-12	0.039		mylar
C162,262	1-105-661-12	0.001		mylar
C163,263	1-107-168-11	91p	500V	silvered mica
C164,264	1-107-253-11	15+18+22+27p	500V	silvered mica
C165,265	1-107-042-11	2.2p	500V	silvered mica
C301	1-121-414-11	100	10V	elect
C302	1-121-726-11	0.47	50V	elect
C303	1-105-679-12	0.033		mylar
C304,305	1-105-673-12	0.01		mylar
308,309				
C401	1-105-676-12	0.018		mylar
C501,601	1-121-913-11	3.3	25V	elect low-noise
C502,602	1-121-404-11	33	25V	elect
C503,603	1-129-896-11	0.012	100V	$\pm 2\%$ plastic
C504,604	1-129-701-11	0.01	100V	$\pm 2\%$ plastic
C505,605	1-129-899-11	0.056	100V	$\pm 2\%$ plastic
C506,606	1-121-391-11	1	50V	elect
C507,607	1-107-119-11	33p		silvered mica
C508,608	1-121-419-11	220	6.3V	elect
C509,609	1-121-398-11	10	25V	elect
C512,612	1-105-670-12	0.0056		mylar
C514,614	1-129-794-11	0.0033	100V	$\pm 2\%$ plastic
C515,615	1-107-103-11	6p		silvered mica
C516,616	1-121-651-11	10	16V	elect
C517,617	1-105-669-12	0.0047		mylar
C518,618	1-131-217-11	2.2		solid tantalum
C519,619	1-131-197-11	3.3		solid tantalum
C520	1-121-404-11	33	25V	elect
C551,651	1-131-215-11	1		solid tantalum
C552,652	1-121-404-11	33	25V	elect
C553,653	1-121-651-11	10	16V	elect
C701	1-121-413-11	100	6.3V	elect
C703	1-121-651-11	10	16V	elect
C704	1-121-420-11	220	10V	elect
C801	1-121-660-11	2200	16V	elect
C802	1-121-659-11	2200	10V	elect

<u>Ref. No.</u>	<u>Part No.</u>	<u>Description</u>
C805	1-121-657-11	1000 25V elect
C808	1-121-402-11	33 10V elect

<u>Ref. No.</u>	<u>Part No.</u>	<u>Description</u>
R553,653	1-242-719-09	82k ¼W low-noise
R555,655	1-242-699-09	12k ¼W low-noise
R705	1-222-762-00	2.2k, adjustable
R901	1-222-765-00	47k, adjustable

RESISTORS

All resistors are in Ω. ¼W, ±5 % carbon type resistors (except special type) are omitted. Check schematic diagram for the resistance values. K = 1000, M = 1000 K

R7	1-224-246-00	10k (B), variable
R8	1-224-245-00	20k (A), variable
R17,27	1-224-244-00	20k (A), variable
R102,202	1-244-721-09	100k ¼W low-noise
R103,203 104,204	1-244-723-09	120k ¼W low-noise
R105,205	1-244-707-09	27k ¼W low-noise
R110,210	1-244-699-09	12k ¼W low-noise
R111,211	1-244-723-09	120k ¼W low-noise
R114,214	1-222-774-00	10k, adjustable
R116,216	1-222-775-00	22k, adjustable
R123,223	1-244-689-09	4.7 ¼W low-noise
R124,224	1-244-733-09	330k ¼W low-noise
R126,226	1-244-723-09	120k ¼W low-noise
R134,234	1-222-773-00	4.7k, adjustable
R151,251	1-222-775-00	22k, adjustable
R501,601	1-210-689-11	100k ¼W ±2%
R502,602	1-210-868-11	12k ¼W ±2%
R503,603	1-242-719-09	68k ¼W low-noise
R504,604	1-242-719-09	82k ¼W low-noise
R505,605	1-242-699-09	12k ¼W low-noise
R506,606 507,607	1-242-737-09	470k ¼W low-noise
R510,610	1-210-853-11	6.2k ¼W ±2%
R511,611	1-242-723-09	120k ¼W low-noise
R512,612	1-242-721-09	100k ¼W low-noise
R516,616	1-242-691-09	5.6k ¼W low-noise
R521,621	1-210-850-11	300 ¼W ±2%
R522,622 523,623	1-210-855-11	33k ¼W ±2%
R524,624	1-210-852-11	5.6k ¼W ±2%
R552,652	1-242-717-09	68k ¼W low-noise

SWITCHES

S1,2	1-514-976-21 ¹⁻⁵⁵²⁻⁸³⁶⁻⁰⁰	Slide, record/playback
S3	1-516-310-00	Lever Slide, DOLBY NR
S4	1-516-298-00	Lever Slide, TAPE SELECT
S5	1-516-310-00	Lever Slide, LIMITER
S6	1-516-441-00	Lever Slide, INPUT SELECT
S7	1-513-273-00	Slide, timing
S8	1-514-486-00	Push, BATTERY CHECK
S9	1-514-486-00	Push, LIGHT
S10	1-514-903-00	Leaf, motor
S11		included in J6 (AC IN)
S12	1-514-564-11	Slide, SP MODE (USA, AEP model)
S13	1-516-298-00	Lever Slide, MIC ATT
S14	1-516-133-00	Lever Slide, SP MONITOR
S15	1-516-259-21	Rocker, POWER (UK model)

JACKS

CNJ1-1~4	1-507-188-00	Mini, LINE IN/LINE OUT
CNJ2	1-509-549-11	Connector, REC/PB (UK, AEP model)
J1,2	1-507-476-XX	Phone, MIC
J3	1-507-476-XX	Binaural, HEADPHONES
J5	1-507-447-XX	DC IN 6V (USA, AEP model)
J6	1-508-624-11	Connector, 2p; AC IN (USA model)
J6	1-509-640-11	Connector, 3p; AC IN (UK model)
J6	1-509-783-11	Connector, 2p; AC IN (AEP model)

<u>Ref. No.</u>	<u>Part No.</u>	<u>Description</u>	<u>Part No.</u>	<u>Description</u>
MISCELLANEOUS			ACCESSORIES & PACKING MATERIALS	
CNJ1	1-507-431-11	Plate, jack	X-3701-018-2	Cleaning Tips (UK, AEP model)
CP1	1-464-022-00	Unit, bias osc		
CP2	1-464-044-00	Unit, DC-DC converter	1-528-022-00	Battery, size "D" (USA model)
EH	8-825-506-00	Head, erase; EF135-36	1-534-049-31	Cord, connection; RK-74
FI,2	1-532-078-00	Fuse, 1AT (UK, AEP model)	1-534-840-11	Cord, power; DK-38 (AEP model)
FG		included in motor	1-534-867-12	Cord, power; DK-35 (USA model)
F308	1-217-424-11	Resistor, fuse; 1.5 ½W (UK, AEP model)	1-534-879-11	Cord, power; DK-44 (UK model)
LPF	1-231-219-00	Unit, low-pass filter	3-533-950-00	Strap, shoulder
M	8-834-009-50	Motor (w/FG coil), D-009F	3-533-962-00	Bag, plastic
ME1	1-520-114-61	Meter, LEVEL	3-533-963-00	Case, accessory
ME2	1-520-114-71	Meter, LEVEL	3-533-964-00	Cushion (R)
PL1,2	1-518-152-00	Lamp	3-533-965-00	Cushion (L)
RPH	8-825-584-00	Head, record/playback; PF145-3602A	3-539-913-00	Carton (USA model)
SP	1-502-455-XX	Speaker, 8 Ω	3-539-914-00	Carton (UK, AEP model)
	1-101-528-11	Encapsulated Component, C-R	3-701-355-00	Label, tack (USA model)
	1-533-102-XX	Holder, fuse (UK, AEP model)	3-701-358-00	Label, tack (AEP model)
			3-701-630-00	Bag, plastic
			3-701-631-00	Bag, plastic
			3-701-680-00	Label, tack (UK model)
			3-780-704-21	Manual, instruction (USA model)
			3-780-704-41	Manual, instruction (UK, AEP model)
			3-793-010-20	Booklet, tape talk
			3-793-044-21	Carton, important (USA model)
			3-793-408-11	Leaflet
			3-793-681-11	Card, caution (AEP model)
			3-793-681-21	Card, caution (USA, UK model)
			3-793-711-11	Card, caution
			3-793-749-00	Card, DOLBY cassette (UK, AEP model)